

THE MARINE NITROGEN CYCLE: OVERVIEW AND CHALLENGES

Nicolas Gruber

Contents

| | |
|---|----|
| 1. Introduction | 1 |
| 2. Overview of Forms, Pools, and Reactions | 4 |
| 2.1. The electronic diversity of nitrogen | 4 |
| 2.2. The major reactions | 6 |
| 2.3. Inventories and residence times | 11 |
| 3. Distributions and Processes | 12 |
| 3.1. Global mean profiles | 12 |
| 3.2. Nitrate | 14 |
| 3.3. Ammonium | 20 |
| 3.4. Nitrite | 24 |
| 3.5. Organic nitrogen | 26 |
| 3.6. Nitrogen*: The imprint of N ₂ -fixation and denitrification | 26 |
| 4. Budgets | 32 |
| 4.1. Oceanic nitrogen budget | 32 |
| 4.2. Global nitrogen budget | 35 |
| 5. Nitrogen Challenges | 37 |
| 5.1. Controls on the marine fixed nitrogen content | 37 |
| 5.2. The marine nitrogen cycle, carbon cycle, and climate | 40 |
| 5.3. The anthropogenic perturbation | 41 |
| 6. Conclusions | 43 |
| Acknowledgements | 43 |
| References | 43 |

1. INTRODUCTION

The marine nitrogen cycle is perhaps the most complex and therefore the most fascinating among all biogeochemical cycles in the sea. As a limiting element for biological productivity, nitrogen occupies a central role in ocean biogeochemistry, exerting a significant influence on cycles of many other elements, in particular carbon

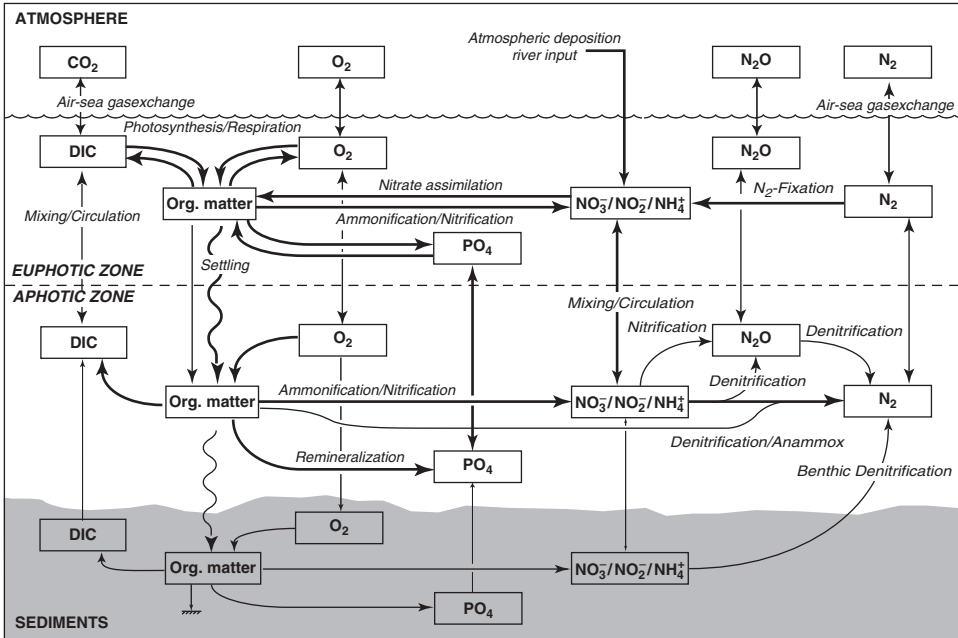

Figure 1.1 Schematic representation of the marine nitrogen cycle and its coupling to the marine cycles of oxygen, phosphorus, and carbon. Of particular importance are the processes of nitrogen fixation and denitrification, which make the fixed nitrogen content of the ocean open to biologically mediated changes.

and phosphorus (see Fig. 1.1). Nitrogen exists in more chemical forms than most other elements, with a myriad of chemical transformations that are unique to this element. Nearly all these transformations are undertaken by marine organisms as part of their metabolism, either to obtain nitrogen to synthesize structural components, or to gain energy for growth. Although most chemical forms of nitrogen in the ocean are bioavailable, the most abundant chemical form, dissolved nitrogen gas (N_2), is generally not. To emphasize this distinction, one often refers to all forms of nitrogen, except N_2 , as *fixed* nitrogen. The general unavailability of N_2 for marine organisms gives the two biological processes of N_2 -fixation, i.e. the conversion of N_2 to organic nitrogen, and denitrification, i.e. the conversion of nitrate to N_2 , a particular importance. The balance of these two processes determines to first order the size of the oceanic inventory of bioavailable nitrogen, and consequently marine productivity. Marine biological processes in interaction with ocean transport and mixing control also the spatio-temporal variations of the various forms of fixed nitrogen within the ocean.

The primary engine that drives these ocean interior variations is the photosynthetic fixation of carbon into organic matter by marine phytoplankton in the light-illuminated upper ocean (euphotic zone) (see Fig. 1.1). Along with carbon, nutrient elements such as nitrogen, phosphorus, iron and many others are taken up and assimilated. Most of the resulting organic matter is either respired or remineralized

in the euphotic zone, but a fraction of it escapes remineralization and is exported into the dark interior ocean (aphotic zone). There, it is remineralized back to its inorganic forms. Finally, these inorganic forms are transported back to the euphotic zone by ocean circulation and mixing, where they can fuel new growth. This coupling between biological and physical processes thus forms a large-scale biogeochemical loop that controls the distribution of nearly all biogeochemically active chemicals in the ocean. I use the expression “loop” here instead of the more commonly used term “biological pump,” as “loop” emphasizes the coupling between the biologically driven downward transport of organic matter and the physically controlled upward transport of inorganic constituents. As a result of this loop, surface concentrations of the inorganic forms of chemicals, particularly limiting nutrients, are low, while the deep ocean is enriched in these inorganic forms. Concomitantly, the concentrations of organic forms, both particulate and dissolved, are high in the near-surface ocean and tend to decrease rapidly with depth.

This biologically driven biogeochemical loop is fundamental for Earth’s climate, as it is one of the processes that determines the concentration of CO₂ in the atmosphere. If this biogeochemical loop were eliminated today, atmospheric CO₂ would raise by more than 200 parts per million (ppm) (Gruber and Sarmiento, 2002). Conversely, if biology became completely efficient in drawing down surface nutrients and exporting the fixed nutrients and carbon to depth, atmospheric CO₂ would fall by more than 100 ppm. Therefore, not surprisingly, changes in the strength of this loop have been invoked from the very beginning as a possible explanation of the large swings in atmospheric CO₂ that occurred over the past million years in association with the glacial–interglacial cycles (e.g., Brzezinski *et al.* (2002); Martin (1990); Sarmiento and Toggweiler (1984); Siegenthaler and Wenk (1984)). Given the key role of nitrogen as a nutrient that limits biological productivity, the hypothesis that alterations of the total amount of fixed nitrogen in the ocean have caused changes in productivity and consequently atmospheric CO₂ is tantalizing (Altabet *et al.*, 1995, 2002; Broecker and Henderson, 1998; Falkowski, 1997; Ganeshram *et al.*, 1995; McElroy, 1983). However, as will be discussed later in this chapter, there are several arguments casting doubts on this hypothesis (see also Gruber (2004) and Chapter 34 by Galbraith *et al.*, this volume).

Interest in the marine nitrogen cycle has soared in the last decade, owing to several converging factors. First is the growing recognition that the immense acceleration of the global nitrogen cycle by humans, largely driven by the fabrication of nitrogen fertilizers from atmospheric N₂ and its subsequent application on agricultural soils (Galloway *et al.*, 2004), is changing not only terrestrial ecosystems and freshwater systems, but increasingly also coastal ecosystems (e.g., Beman *et al.* (2005)). The magnitude of this acceleration becomes evident when one considers that the amount of N₂ fixed each year by industrial processes is of similar magnitude as the amount of nitrogen fixed biologically (Falkowski *et al.*, 2000; Galloway *et al.*, 1995, 2004).

A second factor that has furthered interest in the marine nitrogen cycle is the solidifying evidence that the magnitude of marine N₂ fixation is much larger than was thought 20 years ago when the first *Nitrogen in the marine environment* book was published (see e.g., Capone (2001), Capone *et al.* (2005), Gruber (2005), and Mahaffey *et al.* (2005)). The most recent estimates for global N₂ fixation imply a mean residence

time of fixed nitrogen in the ocean of a few thousand years only (Gruber, 2004), an order of magnitude shorter than that of phosphorus, whose residence time is of the order of several tens of thousands years (Delaney, 1998). This makes the marine nitrogen cycle very dynamic and at the same time susceptible to substantial changes, unless there exist strong negative feedbacks that prevent the marine nitrogen cycle from undergoing large swings. A second consequence of the high rates of N_2 fixation is the recognition that the supply of new nitrogen by N_2 fixation to nitrogen stressed regions of the surface ocean could rival that supplied from below by physical processes (Karl *et al.*, 1997; Capone *et al.*, 2005). This makes N_2 fixation an important player for structuring marine ecosystems in such regions, with substantial implications for how carbon is cycled through the system and what fraction of it is exported.

The third and last factor is the growing concern over how marine biology and the marine nitrogen cycle may respond to future climate change and by their response either accelerate (positive feedback) or decelerate global change (negative feedback) (see e.g., Gruber *et al.* (2004), Gruber and Galloway (2008) or Chapter 35 by Berman-Frank *et al.*, this volume). Of particular concern is the likely decrease of the ocean interior oxygen concentration, which is bound to increase denitrification, and through the resulting decrease in the oceanic nitrogen inventory will lower marine productivity. This would cause a release of natural CO_2 from the ocean, thereby accelerating the CO_2 increase in the atmosphere and the resulting warming. In addition, a decrease in the ocean interior oxygen content will also likely increase the production and release of nitrous oxide, which is a much more powerful greenhouse gas than CO_2 . Therefore, since both these changes would lead to an acceleration of the warming, the marine nitrogen cycle could act as a significant positive feedback factor in a warming world.

This chapter serves as an introduction to the rest of this book, and in many places, the reader is referred to relevant chapters for further details. The focus here is on providing an overview of the most important pools of nitrogen, their transformations, their distribution, and their connection to the cycling of other biogeochemically relevant elements, primarily carbon, oxygen, and phosphorus. The scale is global, as subsequent chapters (Chapters 11–22) cover individual ocean basins and systems. I will also address a series of nitrogen challenges, such as the question of how the marine nitrogen cycle appears to be able to maintain a relatively well established homeostasis, i.e., a balance between gains and losses of fixed nitrogen. Finally, I will discuss the anthropogenic perturbation of the marine nitrogen cycle. As we will see, however, the answers to many of these questions remain elusive, reminding us how little we know about the marine nitrogen cycle, and how much still remains to be discovered.

2. OVERVIEW OF FORMS, POOLS, AND REACTIONS

2.1. The electronic diversity of nitrogen

With 5 relatively stable oxidation states in the marine environment (Fig. 1.2), nitrogen is very distinct from most other nutrient elements. For example, phosphorus, which has the same number of valence electrons, exists in the marine

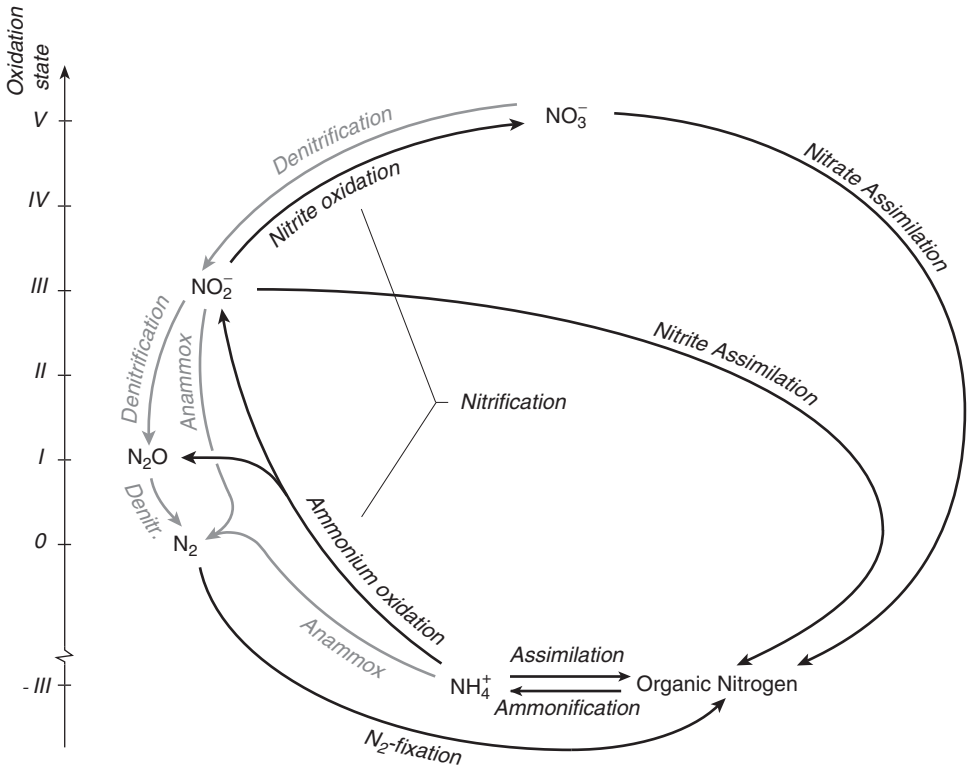

Figure 1.2 Major chemical forms and transformations of nitrogen in the marine environment. The various chemical forms of nitrogen are plotted versus their oxidation state. Processes shown in grey occur in anoxic environments only. See text and Table 1.1 for further details.

environment almost exclusively as ortho-phosphate, i.e., as PO_4^{3-} with an oxidation state of +V. Silicon also exists in the ocean primarily in the +IV oxidation state, i.e., as $\text{Si}(\text{OH})_4$ or SiO_2 (opal). By contrast, nitrogen can be found in the marine environment as nitrate, NO_3^- , with an oxidation state of +V, nitrite, NO_2^- (+III), nitrous oxide, N_2O (+I), molecular nitrogen, N_2 (0), and ammonia, NH_4^+ (-III). In addition, there are a myriad of organic compounds containing nitrogen, most often in the form of amino-groups in the -III oxidation state (see also Chapter 3 by *Aluwihari and Meador*, this volume). Only carbon exhibits a similar range of oxidation states, from -IV in CH_4 to +IV in CO_2 . The basis for the large number of stable oxidation states for nitrogen is its electron configuration, with two of its five valence electrons filling up the 2s orbital and each of the remaining three valence electrons occupying one of the three 2p orbitals. This gives a total electron configuration of $1s^2 2s^2 2p^3$. Stable oxidation states, i.e., a noble gas-like electron configuration, can therefore be achieved if either all five valence electrons are “removed,” giving an oxidation state of +V, or if five electrons are added, giving an oxidation state of -III. The ionization energy for the removal of the five valence electrons is relatively small, so that the gain from forming co-valent bonds can compensate easily for this energy. This provides an explanation for the relative stability of NO_3^- , and NH_4^+ , but it does

not explain the stability of species such as NO_2^- , N_2 or N_2O . However, when considering the reactivity of a compound in the natural environment, one also needs to take into account its bonding energy as well as the activation energy needed to overcome an existing covalent bond.

For nitrogen, the basis for forming stable covalent bonds with other atoms is in most cases the hybridization of its outer s and p orbitals to form either four sp^3 hybrid orbitals or three sp^2 orbitals. In the sp^3 case, the 5 electrons are distributed such that a pair of electrons occupy an unshared sp^3 orbital, while the other three are shared with another atom through covalent bonds. In the case of the sp^2 orbitals, the third p orbital can be used to form π orbitals, which then permits the atom to form double and triple bonds. It is this flexibility, plus the much higher strength of the covalent bonds in the compounds that have double or triple bonds, such as occurs in NO_2^- , N_2 and N_2O , that make so many species of nitrogen stable in the marine environment. Phosphorus shares many of the same characteristics as nitrogen, but because it has 10 more electrons, which occupy the lower orbitals, the energy of many covalent bonds is much lower. Furthermore, these lower orbitals strongly restrict the formation of π orbitals, so that neither silicon nor phosphorus can easily form double or triple bonds. As a result, silicon and phosphorus exist in the marine environment primarily in just one oxidation state.

In summary, the presence of a large number of stable oxidation states for nitrogen in the environment is a result of nitrogen having five valence electrons as well as it being small, giving its electron orbitals a lot of flexibility to rearrange themselves. It is interesting to point out that when comparing carbon, silicon, nitrogen, and phosphorus, the spatial flexibility of the electron orbitals in the smaller elements (carbon, nitrogen) is more important than the number of valence electrons. As a result, nitrogen behaves more like carbon, which has one valence electron less, and less like phosphorus that has the same number of valence electrons.

2.2. The major reactions

The many oxidation states of nitrogen in the marine environment and the resulting large number of nitrogen species give rise to many redox reactions that transform one species to another (Fig. 1.2). In today's ocean, all of the major reactions are mediated by biology, either in association with assimilatory or dissimilatory functions of the involved marine organisms. As discussed in more detail by Berman-Frank *et al.* (Chapter 35, this volume), this was not always the case in Earth's history. For example, biological N_2 fixation evolved much earlier on Earth than biologically driven denitrification (Falkowski 1997).

The most important biologically mediated reactions are summarized in Table 1.1 together with information about the redox environment these reactions take place in, the organisms that are usually conducting these processes, and what biochemical role these processes play for these organisms. I briefly discuss these reactions, but refer to the following chapters for details (see also Table 1.1). For a discussion of a series of additional reactions (e.g. Oxygen-Limited Autotrophic Nitrification-

Table 1.1 Summary of the most important biologically mediated processes transforming nitrogen in the ocean

| Process | Organisms | Redox environment | Trophic status | Biochemical role | Chapter |
|------------------------------|---|-------------------|-------------------|-------------------|---------|
| NO_3^- assimilation | Phytoplankton | Aerob | Photo-autotrophic | Source of N | 7 |
| NO_2^- assimilation | Phytoplankton | Aerob | Photo-autotrophic | Source of N | 7 |
| NH_4^+ assimilation | Phytoplankton | Aerob | Photo-autotrophic | Source of N | 7 |
| Ammonification | Bacteria | Aerob/anaerob | Heterotrophic | Source of N | 7 |
| NH_4^+ oxidation | Bacteria/zooplankton NH_4^+ oxidizers (e.g., <i>Nitrosomonas</i>) | Aerob/anaerob | Heterotrophic | Release of N | 8 |
| NO_2^- oxidation | NO_2^- oxidizers (e.g., <i>Nitrobacter</i>) | Aerob | Chemo-autotrophic | Source of energy | 5 |
| Denitrification | Bacteria | Anaerob | Heterotrophic | Electron acceptor | 6 |
| Anammox | Bacteria | Anaerob | Chemo-autotrophic | Source of energy | 6 |
| N_2 -fixation | Cyanobacteria, etc. (e.g., <i>Trichodesmium</i>) | Aerob | Photo-autotrophic | Source of N | 4 |

Denitrification, OLAND), the interested reader is referred to the review by [Brandes et al. \(2007\)](#).

The *assimilation of nitrate or ammonium* into organic nitrogen by marine phytoplankton in order to satisfy their nitrogen demand for growth is the process that quantitatively dominates the marine nitrogen cycle. NH_4^+ is thought to be the preferred source of fixed nitrogen for phytoplankton, because its assimilation does not involve a redox reaction and therefore requires little energy ([Zehr and Ward, 2002](#)). It is therefore not surprising that all phytoplankton can grow on NH_4^+ as the only nitrogen source. By contrast, the assimilation of NO_3^- involves the reduction of nitrogen from an oxidation state of +V to -III, i.e., the transfer of eight electrons, which requires the investment of a substantial amount of energy. Since NO_3^- in the ocean is generally much more abundant than NH_4^+ (see below), most phytoplankton have the enzymes necessary to undertake this reduction (nitrate reductase), with a few notable exceptions. The best studied organisms lacking the ability to use NO_3^- as a nitrogen source are *Prochlorococcus* and certain strains of *Synechococcus* ([Moore et al., 2002](#)). All phytoplankton that can use NO_3^- can also use NO_2^- as a source of nitrogen. This is because NO_2^- is an intermediary product during the assimilation of NO_3^- . However, NO_2^- is usually only a very minor source of nitrogen for phytoplankton, as its concentration is often an order of magnitude lower than that of NO_3^- or NH_4^+ (see below).

The assimilation of nitrogen by phytoplankton is strongly linked to the photosynthetic fixation of carbon, because both elements are needed in order to build living organic tissue. The same applies to the assimilation of phosphate. Since most phytoplankton appear to have a relatively fixed cell quota for protein, lipids, carbohydrates, and DNA/RNA (see e.g., [Hedges et al. \(2002\)](#)), they tend to take up these different elements with a relatively fixed ratio, permitting us to write the synthesis of organic matter by the coupled assimilation of CO_2 , NO_3^- , and PO_4^{3-} as:

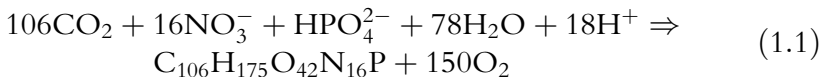

and in the case when NH_4^+ is used as nitrogen source:

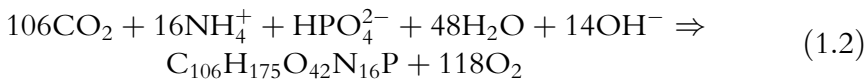

where $\text{C}_{106}\text{H}_{175}\text{O}_{42}\text{N}_{16}\text{P}$ denotes the average composition of organic matter in phytoplankton, and where I used the stoichiometric ratios of [Anderson \(1995\)](#). Note that these ratios differ from those originally proposed by [Redfield et al. \(1963\)](#), in particular with regard to the production of O_2 . The uptake of NO_3^- and NH_4^+ has a notable impact on the photosynthetic quotient (PQ), i.e., the stoichiometric ratio between the uptake of CO_2 and the release of O_2 , with the uptake of NO_3^- having a PQ of 1.4 and the uptake of NH_4^+ having a PQ of 1.1 (*cf.* [Laws \(1991\)](#)).

It is important to recognize that the stoichiometric ratios used in [Eqs. \(1.1\) and \(1.2\)](#) are averages, and that any given phytoplankton sample may deviate substantially

from these mean ratios (see e.g., Klausmeier *et al.* (2004) and discussion in Chapters 37 and 38). However, water column data suggest that when averaged sufficiently over space and time, these ratios hold up remarkably well (e.g., Takahashi *et al.* (1985)). As I will demonstrate below, the concept of constant stoichiometric ratios, often termed *Redfield ratio concept*, is very powerful to investigate and understand the large-scale distribution of nitrogen species in the ocean, and how their distribution is linked to that of other elements, in particular carbon and phosphorus.

Most of the fixed organic nitrogen in the ocean is returned back to nitrate by remineralization processes. This occurs in three distinct steps: *ammonification*, *ammonium oxidation*, and *nitrite oxidation*, where the latter two processes in combination are often referred to as *nitrification* (see Fig. 1.2 and Chapter 5 by Ward, this volume). Ammonification is the reverse process of the NH_4^+ assimilation reaction (1.2), i.e., the transformation of organic nitrogen to NH_4^+ . Most of this process is done by heterotrophic bacteria, which use the oxidation of organic carbon to CO_2 as a source of energy, but release the organic nitrogen then as NH_4^+ as they lack the ability to oxidize it to NH_4^+ or NO_3^- . This latter step is undertaken by a specialized group of bacteria, which are using the oxidation of NH_4^+ to NO_3^- as a source of energy, i.e., they are chemo-autotrophic. The two steps of nitrification, the oxidation of NH_4^+ to NO_2^- , and the oxidation of NO_2^- to NO_3^- are most often done by two distinct groups of organisms. The best known are *Nitrosomonas spp.*, an ammonium oxidizer, and *Nitrobacter spp.*, a nitrite oxidizer. Nitrification requires the presence of O_2 and tends to be inhibited by light, which has important implications for the upper ocean nitrogen cycle, as I will discuss below. To summarize, the following three distinct reactions remineralize organic nitrogen to nitrate:

The heterotrophic process of ammonification, which is the return pathway of NH_4^+ assimilation (reaction 1.2):

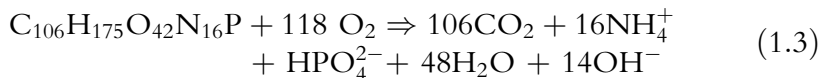

and the two processes of aerobic nitrification, i.e., ammonium oxidation, and nitrite oxidation:



The vast majority of the oxidation of organic matter follows reaction (1.3) involving oxygen as the terminal electron acceptor. Most higher organisms are strict aerobes, i.e., they cannot switch to another oxidant, and therefore cannot live in the absence of free oxygen. In contrast, most bacteria are more flexible and can use a wide range of other electron acceptors, including sulfate, manganese, and iron. However, the first electron acceptor that is generally being used by bacteria in the ocean is NO_3^- , resulting in a process called *denitrification*. The preference of NO_3^- over other electron acceptors is because of the higher energy yield of

denitrification in comparison to the use of the alternative oxidants. Using organic matter with the stoichiometry shown in (1.1), heterotrophic denitrification can be written as:



Another anaerobic process that removes bio-available nitrogen from the water is the anaerobic oxidation of ammonium (*Anammox*), in which ammonium and nitrite are combined to form N_2 , thus

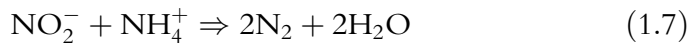

In contrast to denitrification, the Anammox reaction is used as a source of energy, i.e., the Anammox bacteria are chemo-autotrophic (Strous *et al.*, 1999). This process, first uncovered in wastewater bioreactors, has been demonstrated to occur in marine environments only very recently (see e.g., Kuypers *et al.* (2003) and Dalsgaard *et al.* (2003)). Its quantitative significance is not known yet on a global scale, but a recent study suggested that anammox rather than canonical denitrification is the primary process causing the fixed nitrogen loss in the oxygen minimum zone of the Benguela upwelling system (Kuypers *et al.*, 2005). It is unlikely that this conclusion can be easily extrapolated, since the requirement for NO_2^- in an anoxic environment means that another process must supply this reactant. The most likely candidate is the partial denitrification of NO_3^- , which means that the anammox bacteria tend to have to compete with denitrifying bacteria for the same resources. But given how little we know about this process and the associated organisms, there is ample room for surprises.

From a geochemical perspective, denitrification and anammox have the same implication, i.e., they both lead to a loss of fixed nitrogen from the ocean, albeit with a somewhat different stoichiometry. This loss requires a counterbalancing source elsewhere if fixed nitrogen in the ocean is to be maintained at roughly constant levels through time.

The most important source for fixed nitrogen in the ocean is *biological N_2 fixation*, which refers to the conversion of N_2 into organic nitrogen. It is undertaken in the ocean primarily by photoautotrophic organisms in order to obtain nitrogen in environments where fixed nitrogen is usually exhausted. The most conspicuous and best studied N_2 fixing organism (diazotroph) is *Trichodesmium* (Capone *et al.*, 1997), although there are many other organisms known to fix nitrogen, including uni-cellular bacteria (Zehr *et al.*, 2001), and cyanobacteria that live endosymbiotically within marine diatoms (e.g., Carpenter *et al.* (1999)). The magnitude of marine N_2 fixation has been a topic of intense research and discussion in the last two decades (see e.g., Capone (2001)). In particular, the extent to which the oceanic fixed nitrogen budget is actually in balance is controversial at present, as I will discuss below (e.g., Codispoti (2006); Codispoti *et al.* (2001); Codispoti and Christensen (1985); Gruber (2004); Gruber and Sarmiento (1997); McElroy (1983)).

Organic nitrogen is seldom completely converted to NO_3^- or N_2 during either nitrification or denitrification. Some small fraction ends up as nitrous oxide, N_2O

(Fig. 1.2), most of which escapes to the atmosphere (see Fig. 1.1 as well as Chapter 2 by Bange, this volume). Nitrous oxide acts as a greenhouse gas that is more than 200 times more potent than CO_2 (Ramaswamy *et al.*, 2001). Therefore variations of this gas in the atmosphere can lead to changes in Earth's temperature and climate. Since the oceanic emission of N_2O constitutes a substantial fraction to the total emission of N_2O into the atmosphere, N_2O provides for a direct potential link between the ocean nitrogen cycle and Earth's climate.

In the case of aerobic remineralization, the formation of N_2O is associated with the oxidation of ammonium during nitrification (see Fig. 1.2). Nitrous oxide is also formed during denitrification, as it represents an intermediary product during the reduction of NO_3^- to N_2 (Fig. 1.2). If some of this N_2O escapes the further reduction to N_2 , denitrification can act as a source of N_2O . At the same time, denitrification can act as a sink for N_2O in cases where N_2O produced elsewhere is transported into a region of active denitrification. The overall balance generally is believed to be positive, i.e., denitrification is thought to act as a net source of N_2O (Suntharalingam *et al.*, 2000). The relative importance of the two production pathways is still debated, but it appears as if the majority of the N_2O in the ocean is formed in association with nitrification (Jin and Gruber, 2003; Nevison *et al.*, 2003; Suntharalingam and Sarmiento, 2000). However, given the much higher yield of N_2O at low oxygen concentrations, the production is biased toward the low oxygen regions of the world ocean.

2.3. Inventories and residence times

Table 1.2 shows a summary of the oceanic inventories of the major forms of nitrogen in the ocean and their estimated residence times with regard to key processes or the ocean fixed nitrogen inventory as a whole.

By far the largest amount of nitrogen in the ocean (about 1×10^7 Tg N, or about 94%) exists in the form of bioavailable N_2 . The majority of the remaining fixed forms of nitrogen occurs as NO_3^- (about 88%), followed by *DON*, which makes up nearly all of the remaining 12%. The other forms, *PON*, NO_2^- , NH_4^+ , and N_2O have similar oceanic inventories, but together represent less than 0.3% of the total fixed nitrogen pool. The dominance of N_2 in the ocean is entirely due to its inertness, as the thermodynamically most stable form would be NO_3^- . This explains its high abundance relative to NO_2^- or NH_4^+ , but the high inventory of *DON* is remarkable, since one would expect that organic nitrogen is remineralized relatively rapidly. However, as will be discussed by *Aluwihare and Meador* in Chapter 3, certain constituents of *DON* are very refractory.

The different nitrogen species differ by more than 6 orders of magnitude in terms of their turnover times. Due to its large inventory and its inertness, the turnover time of dissolved N_2 with respect to N_2 fixation and/or denitrification is by far the longest, i.e., more than 50,000 years. By contrast, NO_3^- in the ocean gets turned over two orders of magnitude faster, i.e., once every 400 years. Due to their much smaller inventories and even larger turnover rates, NH_4^+ and *PON* have an even shorter turnover time, amounting to one to two weeks only. The estimated turnover time for *DON* is about 20 years, but this represents a mean turnover time for bulk *DON*. In

Table 1.2 Oceania Inventory, Turnover Rates, and Residence Times for the Major Fixed Nitrogen Species in the Ocean

| Species | Mean conc. euphotic zone (mmol m ⁻³) | Mean conc. aphotic zone (mmol m ⁻³) | Oceanic inventory (Tg N) | Turnover rate ⁱ (Tg N yr ⁻¹) | Turnover time (years) |
|--|--|---|--------------------------|---|-----------------------|
| Nitrate, NO ₃ ^{-a} | 7 | 31 | 5.8 × 10 ⁵ | 1,570 | 370 |
| Nitrite, NO ₂ ^{-b} | 0.1 | 0.006 | 160 | | |
| Ammonium, NH ₄ ^{+c} | 0.3 | 0.01 | 340 | 7,000 | 0.05 |
| Dissolved Organic N, DON ^d | 6 | 4 | 7.7 × 10 ⁴ | 3,400 | 20 |
| Particulate Organic N, PON ^e | 0.4 | 0.01 | 400 | 8,580 | 0.05 |
| Nitrous oxide, N ₂ O ^f | 0.01 | 0.04 | 750 | 6 | 125 |
| Fixed Nitrogen ^g | | | 6.6 × 10 ⁵ | 200 | 3,300 |
| Nitrogen gas, N ₂ ^h | 450 | 575 | 1 × 10 ⁷ | 200 | 54,000 |

^a Based on World Ocean Atlas, 2001 (WOA01) (Conkright *et al.*, 2002). Estimated uncertainty less than ±5%.

^b Based on data from the World Ocean Circulation Experiment, average profile. Estimated uncertainty about ±20%.

^c Average profile from 4 process studies of the Joint Global Ocean Flux Study data, see also Fig. 1.3. Estimated uncertainty about ±20%.

^d Based on Bronk (2002) with an uncertainty of about ±30%. Turnover rate based on her estimate that about 40% of N uptake by phytoplankton ends up as DON.

^e Based on Sharp (1983) with an uncertainty of about ±50%.

^f Based on Nevison *et al.* (2003) with an uncertainty of about ±20%.

^g Sum of NO₃⁻, NO₂⁻, NH₄⁺, DON, PON, and N₂O.

^h Computed from global temperature and salinity distribution (WOA01) assuming 100% saturation. Estimated uncertainty about ±10%.

ⁱ See Fig. 1.14 for sources of rate estimates.

reality, the different components of DON have been estimated to have turnover times from a few minutes to many hundreds of years (Bronk, 2002). N₂O has a remarkably long residence time of about 125 years. This primarily reflects the absence of strong oceanic sinks for N₂O, as only the loss to the atmosphere and reduction to N₂ in anoxic regions can remove N₂O from the ocean once it has been produced.

3. DISTRIBUTIONS AND PROCESSES

3.1. Global mean profiles

Sufficient data for computing global mean profiles for nitrogen species exist only for NO₃⁻ and NO₂⁻. An approximation for a global mean profile for NH₄⁺ can be obtained by simply averaging all available data, which are somewhat unevenly

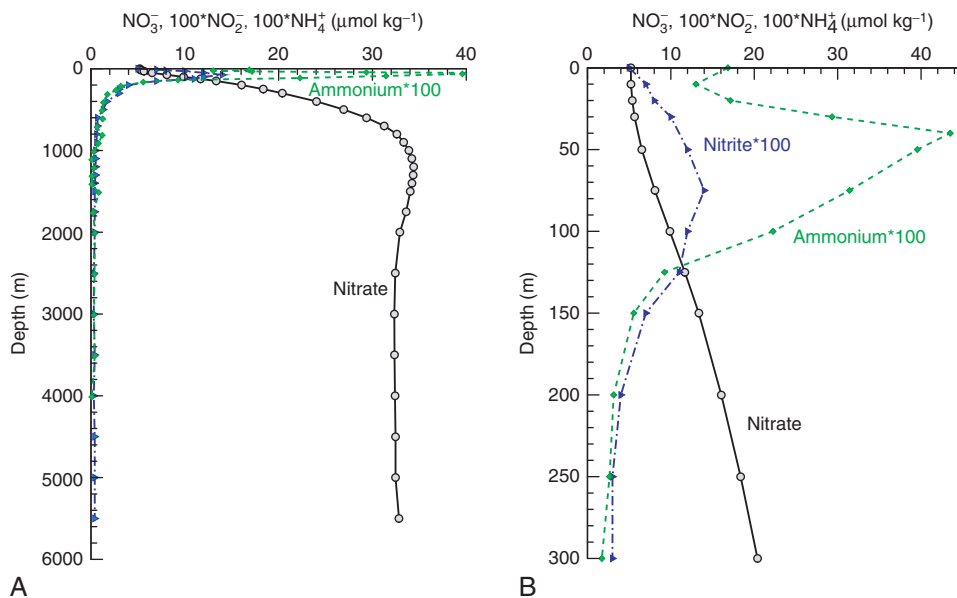

Figure 1.3 Global mean profiles of NO_3^- , NO_2^- , and NH_4^+ (A) for the entire water column (0–6000 m), and (B) for the upper 300 m only. Note that the NH_4^+ and NO_2^- concentrations were multiplied by a factor of 100 to see their variations. The NO_3^- profile is based on data from the World Ocean Atlas 2001 (Conkright *et al.*, 2002). The NO_2^- profile was computed by averaging all data from the World Ocean Circulation Experiment (data taken from whpo.ucsd.edu). The NH_4^+ profile is based primarily on data from the Arabian Sea, the Southern Ocean, the North Atlantic, and the Equatorial Pacific (using data from the Joint Global Ocean Flux Study (JGOFS) available at usjgofs.whoi.edu) and augmented by data from a few sites provided by the GLOBEC program (www.usglobecc.org).

distributed, but cover the most important regions of the world's ocean. N_2O will not be discussed here, as it is the main focus of Chapter 2 by Bange, this volume.

The mean vertical profiles of NO_3^- and NO_2^- show a very different behavior (Fig. 1.3). Nitrate exhibits the expected near-surface depletion and enrichment at depth driven by the biogeochemical loop (biological pump). In contrast, NO_2^- and NH_4^+ show a maximum around 50 to 80 m, i.e., in the lower parts of the euphotic zone, and rapidly decreasing concentrations below that depth. This distribution as well as their much lower mean concentrations reflect their status as intermediary nitrogen species, i.e., species that are both rapidly produced and consumed throughout the water column. These two labile species accumulate only to an appreciable level when their generation rate overwhelms their consumption. For NH_4^+ this occurs generally somewhere in the deeper parts of the euphotic zone, where organic nitrogen is rapidly remineralized, liberating large amounts of NH_4^+ , but where NH_4^+ uptake by phytoplankton may be limited already by light. Near the bottom of the euphotic zone or below, where light levels are low enough for nitrification to escape light inhibition, part of this NH_4^+ is oxidized to NO_3^- , creating NO_2^- alongside. NO_2^- is also created as an intermediary product higher up in the euphotic

zone during the assimilation of NO_3^- . In the aphotic zone, neither NO_2^- nor NH_4^+ occur at any appreciable level, as they tend to be rapidly converted to NO_3^- by nitrification. An exception are the low oxygen regions, as discussed below.

3.2. Nitrate

3.2.1. Surface distribution

Over most of the surface ocean, the concentration of NO_3^- is below detection level (Fig. 1.4a). The only exceptions are the low-latitude upwelling regions, and the high latitudes. The coastal upwelling regions are accompanied with high levels of chlorophyll, as expected. In contrast, the high surface nitrate concentrations in the Southern Ocean, the equatorial Pacific, and the North Pacific have long been an enigma for marine biologists (see e.g., Cullen (1991)) as these regions exhibit uncharacteristically low chlorophyll levels. In response, they are often referred to as *High-Nutrient Low-Chlorophyll (HNLC)* regions.

In order to explain the HNLC regions, we first have to consider the processes that control surface nitrate. To first order the surface NO_3^- concentration reflects the balance between vertical NO_3^- supply and biological consumption and export. As a consequence, the residual NO_3^- at the surface is a poor indicator of the production and export of an ocean ecosystem, i.e., the surface NO_3^- concentration is poorly related to the strength of the biological pump (Sarmiento and Gruber, 2006). The residual surface NO_3^- concentration is by definition, however, a good indicator of the efficiency of the biological pump, i.e., a measure of how successful biology is in taking up nutrients and exporting them to depth against the physical resupply of new nutrients. This means that the question of what maintains the HNLC regions is equivalent to asking why the biological pump is so inefficient there.

Physiologically, phytoplankton are usually extremely efficient in taking up NO_3^- and the enzymes operate well down to very low concentrations (see discussion by Mulholland and Lomas in Chapter 7, this volume). Therefore, something else must be limiting phytoplankton growth and/or its biomass. Light-limitation, grazing, and low temperatures were proposed as an explanation (Cullen, 1991), but the current consensus is that iron limitation is the primary reason for the HNLC regions, as impressively demonstrated by a series of open-ocean iron fertilization experiments (Boyd *et al.*, 2000, 2004; Coale *et al.*, 1996, 2004; Martin *et al.*, 1994; Tsuda *et al.*, 2003).

The discussion of the distribution of surface NO_3^- in terms of biological pump efficiency is particularly useful for understanding the impact of the biological pump on the ocean carbon cycle and atmospheric CO_2 . This is because surface nutrients are an excellent indicator for the direction of the biologically induced air-sea flux of CO_2 . In a case where the biological pump is 100% efficient, all remineralized inorganic carbon that is brought to the surface together with the nutrients is taken up by phytoplankton and mostly exported back down again. As a result, little or no CO_2 can escape to the atmosphere. In contrast, regions where the biological pump is inefficient, much of the inorganic carbon transported upward to the surface remains there along with the unused nutrients, so that a significant fraction of it can escape into the atmosphere. In steady-state, this biologically induced outgassing of CO_2 has to be compensated by uptake in other regions. This occurs in regions of high

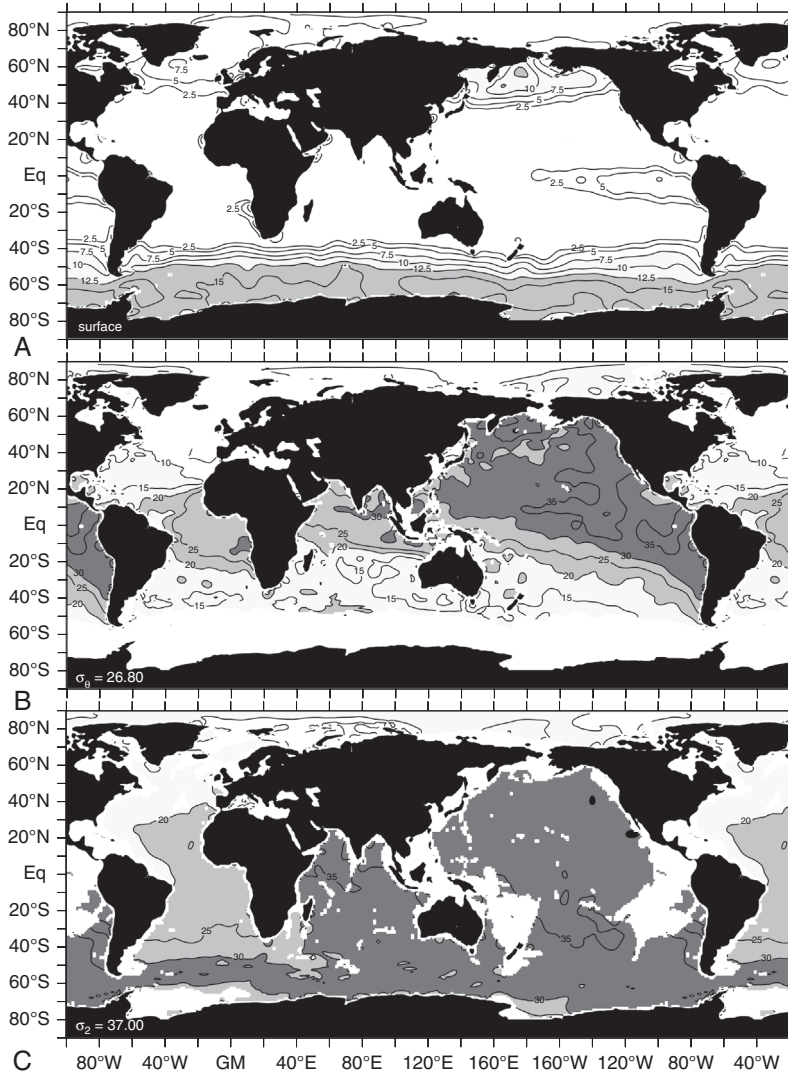

Figure 1.4 Maps of annual mean nitrate concentrations at (a) surface, (b) on the isopycnal surface $\sigma_0 = 26.80$ representing Subantarctic Mode Water in the southern hemisphere, and subpolar mode waters in the northern hemisphere, and (c) on the isopycnal surface $\sigma_2 = 37.00$ representing North Atlantic Deep Water. Based on data from the World Ocean Atlas 2001 (Conkright *et al.*, 2002).

biological efficiency, where part of the fixed and exported organic carbon stems from inorganic carbon taken up from the atmosphere.

In summary, regions with low biological efficiency have high residual NO_3^- and tend to be biologically induced sources of CO_2 to the atmosphere. Regions with high biological efficiency have very low residual NO_3^- and tend to be biologically

induced sinks for atmospheric CO_2 . Thus, in order to change atmospheric CO_2 , one needs to make the biological pump primarily more efficient and not necessarily stronger. I will come back to this issue in the section on “nitrogen challenges.”

3.2.2. Interior ocean distribution

Nitrate at depth exhibits much more spatial variation than revealed in the smooth global mean profile shown in Fig. 1.3. This is illustrated in Fig. 1.5a, which depicts the NO_3^- concentration along a global-scale vertical section that starts in the North Atlantic, goes south along approximately 20°W into the Southern Ocean, wraps around Antarctica at about 60°S , turns north at about 150°W , and ends up in the North Pacific (see map inset). NO_3^- increases very rapidly with depth in the upper 500 m of the tropics, while the vertical gradients are much smaller in the upper 500 m of the mid-latitudes. Below a 1000 m, the NO_3^- distribution follows an entirely different pattern, as the main gradients are horizontal, going from low concentrations in the deep Atlantic to high concentrations in the deep Pacific.

These variations in NO_3^- are highly correlated with variations in PO_4^{3-} and dissolved inorganic carbon (*DIC*) (Fig. 1.6), with a slope close to the stoichiometric ratio of photosynthesis and respiration, implying that the distribution of these constituents are primarily controlled by the biogeochemical loop. But how are the two main processes of this loop, i.e., biology and ocean circulation interacting with each other to create these spatial variations? For example, are the stronger vertical gradients in the tropics primarily a result of higher export of organic nitrogen and subsequent higher rates of remineralization at depth, or are there other mechanisms at work?

Let us explore the thermocline distribution first. As large-scale oceanic transport occurs primarily along surfaces of equal potential density, it is instructive to inspect variations along such surfaces. Figure 1.4b shows the NO_3^- distribution along the potential density surface $\sigma_\theta = 26.80$, which represents Sub-Polar Mode Water (SPMW) in the northern hemisphere and Sub-Antarctic Mode Water (SAMW) in the southern hemisphere (Hanawa and Talley, 2001). Nitrate concentrations near the outcrops, i.e., where the isopycnal surface intersects the surface of the ocean are near zero, but concentrations increase rapidly as one moves away from the outcrops into the ocean’s interior.

The large-scale circulation on this isopycnal surface consists of a series of anticyclonic gyres that are confined to each hemisphere. Along the anticyclonic path of these gyres, the waters flow near the surface at the poleward outcrops, and descend to depth along the eastern side of the basin, bringing young, recently ventilated water from the surface into the interior. The gyre flow stays generally poleward of 20° on the equatorward side, and then becomes part of the western boundary current along the gyre’s western flank. The interaction of this flow pattern with the continuous addition of NO_3^- from remineralization (nitrification) is best seen in the North Atlantic, where the younger waters in the northeastern part of the gyre have the lowest NO_3^- concentrations, and where concentrations gradually increase along the path of the gyre. The time it takes for an average water parcel to make one journey around this basin-scale gyre is on the order of years to decades (Follows *et al.*, 2002; Sarmiento *et al.*, 1982), resulting in a moderate increase in the NO_3^-

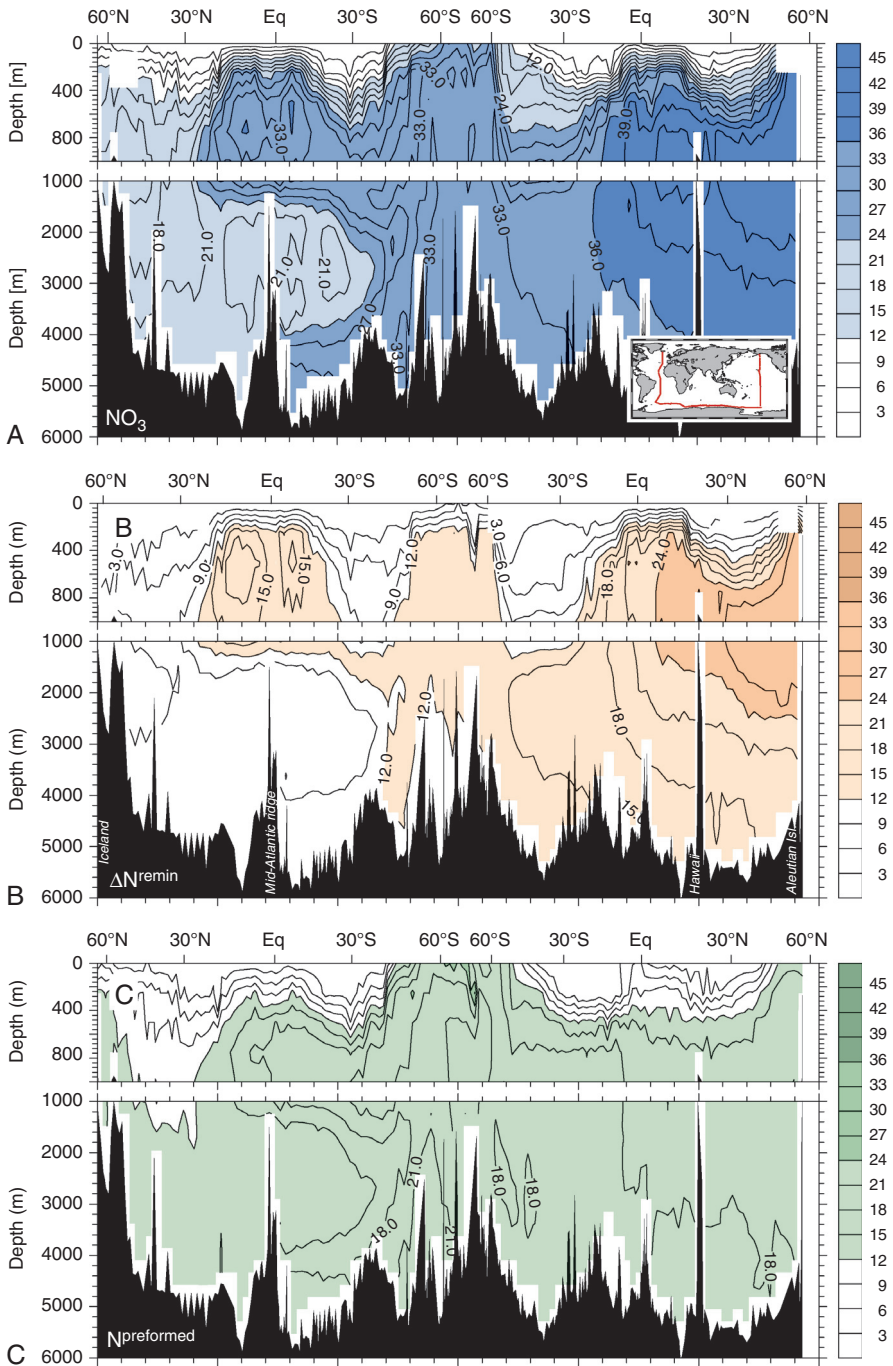

Figure 1.5 Vertical sections of (A) nitrate, (B) remineralized nitrate, and (C) preformed nitrate (all in $\mu\text{mol kg}^{-1}$) along a section that follows the global conveyor belt circulation (see map inset in (A)). Based on WOCE data from the A16, S4, and P16 cruises.

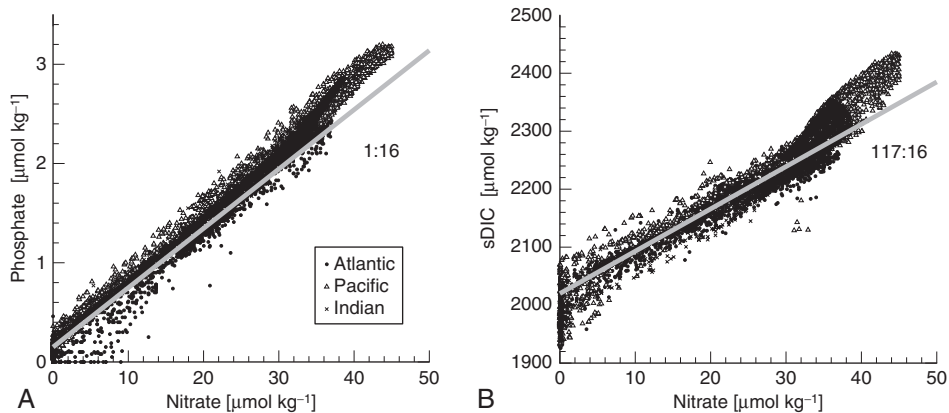

Figure 1.6 Plots of co-variances of (A) phosphate, and (B) dissolved inorganic carbon (*DIC*) with nitrate. *DIC* has been normalized to a constant salinity of 35 in order to remove the effect of fresh-water fluxes. Based on data from all depth and from selected cruises of the World Ocean Circulation Experiment, i.e., A16, 18N19S, P16. The lines indicate the expected biologically induced trends.

concentration despite high rates of organic matter remineralization and hence high rates of NO_3^- addition from nitrification.

These basin-scale gyres do not reach the low-latitude regions of these isopycnals, however, resulting in a very poor water renewal in these regions. Consequently, NO_3^- and other nutrients tend to accumulate, while oxygen tends to be consumed. In certain regions, particularly in the eastern parts of the tropical thermocline, this consumption proceeds until all oxygen is consumed, creating conditions conducive for water-column denitrification.

The distribution of NO_3^- on the deep-ocean isopycnal $\sigma_2 = 37.00$ (Fig. 1.4c), representing North Atlantic Deep Water (NADW), illustrates the large-scale increase of NO_3^- from the Atlantic to the Pacific in more detail than the vertical section (Fig. 1.5a). Two observations on this deep isopycnal surface contrast with the NO_3^- distribution on the thermocline surface. First, concentrations near the outcrop regions are not near-zero. In the North Atlantic, the NO_3^- concentration at the outcrop is about $15 \mu\text{mol kg}^{-1}$, and in the Southern Ocean, the outcrop concentration of NO_3^- exceeds $30 \mu\text{mol kg}^{-1}$. Second, the horizontal gradients are generally smoother, showing no distinction between the tropics and the mid-latitudes. The latter observation reflects the very different flow pattern of the deep ocean, which is dominated by the lower branch of the global overturning circulation (Broecker, 1991). This circulation supplies newly ventilated waters to the deep ocean at two locations only: the high-latitude North Atlantic and the high-latitude Southern Ocean. From the North Atlantic, newly formed NADW is transported southward into the Southern Ocean, where it mixes with waters that are ventilated around Antarctica. This mixture provides then the source waters for the deep Indian and Pacific Oceans. Along this global-scale journey, which starts in the North Atlantic and ends in the North Pacific, water parcels slowly accumulate NO_3^- stemming from the remineralization of organic nitrogen falling through the water column.

Not all of the variations of nitrate on this isopycnal surface are due to remineralization processes, however. We need to consider also the contribution that stems from the mixing of surface source waters that already contain a significant amount of NO_3^- . This *preformed* nitrate is evident in the non-zero outcrop values noted above in Fig. 1.4a. In order to isolate the impact of remineralization on the interior ocean NO_3^- distribution, one therefore needs to separate the observed NO_3^- into a preformed and a *remineralized* component, where the latter refers to the amount of NO_3^- that has been added to a water parcel since it was last in contact with the atmosphere, thus:

$$[\text{NO}_3^-]_{\text{observed}} = [\text{NO}_3^-]_{\text{preformed}} + \Delta[\text{NO}_3^-]_{\text{remineralized}}. \quad (1.8)$$

We can accomplish this separation for NO_3^- by taking advantage of this separation being relatively straightforward for O_2 , since surface O_2 concentrations are often close to saturation. Setting preformed oxygen equal to the O_2 saturation concentration, $[\text{O}_2]_{\text{sat}}$, and assuming that the stoichiometry of O_2 consumption and NO_3^- release during remineralization is constant with a ratio, $r_{\text{N}:\text{O}_2}$, we can estimate the remineralized component:

$$\Delta[\text{NO}_3^-]_{\text{remineralized}} = r_{\text{N}:\text{O}_2} \cdot ([\text{O}_2]_{\text{sat}} - [\text{O}_2]_{\text{observed}}). \quad (1.9)$$

The preformed component is estimated by difference. This separation is only an approximation, however, as preformed oxygen sometimes deviates substantially from its saturation value (see discussion by Ito *et al.* (2004)). In such cases, one would need to employ an estimate of the true preformed oxygen. For our illustrative purposes here, we neglect this potential limitation.

Figure 1.5c shows that preformed NO_3^- represents a very substantial fraction of the total NO_3^- in the thermocline and deep ocean, and that it is responsible for about half of the surface to deep gradient in NO_3^- . It also shows that much of the NO_3^- increase in the deep Atlantic along the path of NADW is actually caused by mixing of a high preformed NO_3^- end-member from the Southern Ocean while the NO_3^- increase from remineralization is relatively small (Fig. 1.5b). The highest concentrations of remineralized NO_3^- are found in the thermocline, as expected from the fact that about 90% of the organic nitrogen exported from the upper ocean is remineralized above 1000 m (e.g., Martin *et al.* (1987)).

The existence of a significant amount of preformed NO_3^- in the ocean is a direct consequence of the low biological pump efficiency in the surface regions that ventilate the interior ocean. Since the Southern Ocean is a source region for most of the deep waters in the Ocean, the inability of biology to draw down the nutrients there leaves a global-scale imprint on the ocean interior distribution of NO_3^- . This gives biology in the Southern Ocean a uniquely large leverage on global-scale biogeochemistry (Sarmiento *et al.*, 2004). Increasing the biological pump efficiency in this region would not only draw down the (preformed) nutrients locally, but it would also prevent these nutrients from being exported laterally to low-latitude regions by SAMW and Antarctic Intermediate Waters (see elevated preformed NO_3^- concentrations in the mid thermocline of the Southern hemisphere in Fig. 1.5c). These preformed nutrients

eventually end up at the surface of the lower latitudes, fueling productivity there. Therefore, any increase in the biological pump efficiency in the Southern Ocean, such as induced by iron fertilization or Southern Ocean stratification, causes a drop in low-latitude productivity after some delay (Jin and Gruber, 2003; Sarmiento and Orr, 1991; Sarmiento *et al.*, 2004). In a model experiment, Sarmiento *et al.* (2004) showed that making the biological pump 100% effective in the Southern Ocean would cause, in steady state, low-latitude productivity north of 30°S to decrease 4-fold. Therefore, consideration of such downstream effects is very important when considering past or future changes in the oceanic nitrogen cycle.

3.3. Ammonium

The inventory of NH_4^+ in the ocean is approximately three orders of magnitude smaller than that of NO_3^- . Nevertheless, the cycling of NH_4^+ in the ocean is a crucial component of the upper ocean nitrogen cycle. In fact, the chemical distinction of NO_3^- versus NH_4^+ permits oceanographers to investigate the sources and fate of nitrogen in the upper ocean in a much more detailed way than it would be possible if nitrogen existed just in one major chemical form, such as is the case for PO_4^{3-} , for example.

3.3.1. Distribution

Relative to NO_3^- and NO_2^- , the concentration of NH_4^+ is seldom measured in the open ocean, resulting in a much more patchy understanding of its distribution. This is because standard techniques do not work well at the very low concentrations usually encountered, requiring special high-sensitivity methods (see e.g., Brzezinski (1988), Jones (1991), and Clark *et al.* (2006)). An exception are the four major process studies undertaken as part of the U.S. component of the Joint Global Ocean Flux Study (JGOFS), i.e., the AESOPS study in the Southern Ocean, the Arabian Sea study, the EqPac program in the Equatorial Pacific, and the NABE experiment in the North Atlantic, as well as a few individual efforts (e.g., Varela *et al.* (2005)). Average profiles of NH_4^+ for each of the four JGOFS process studies are shown in Fig. 1.7, together with those for NO_3^- , NO_2^- , and *PON*.

Several observations stand out. Although the euphotic mean concentration of NH_4^+ averaged from all regions is about $0.3 \mu\text{mol kg}^{-1}$ (see Fig. 1.3), the concentration varies by almost an order of magnitude between the Southern Ocean and the Arabian Sea. Since the NH_4^+ concentration reflects the balance between production by ammonification and consumption by NH_4^+ assimilation or nitrification, differences in any of these processes could explain this large range. The positive correlation between high concentrations of *PON* and NH_4^+ (Fig. 1.7C and D) suggests that higher rates of ammonification are the primary cause, but the much colder temperatures in the Southern Ocean and the resulting lower rates of nitrification, as well as strongly differing values of NO_3^- , may also contribute.

During these four process studies, the average concentration of NH_4^+ was generally much lower than that of NO_3^- . It is not clear whether this applies globally, but the few available data from the oligotrophic regions suggest that NH_4^+ is extremely low there, and likely lower than NO_3^- (Brzezinski, 1988).

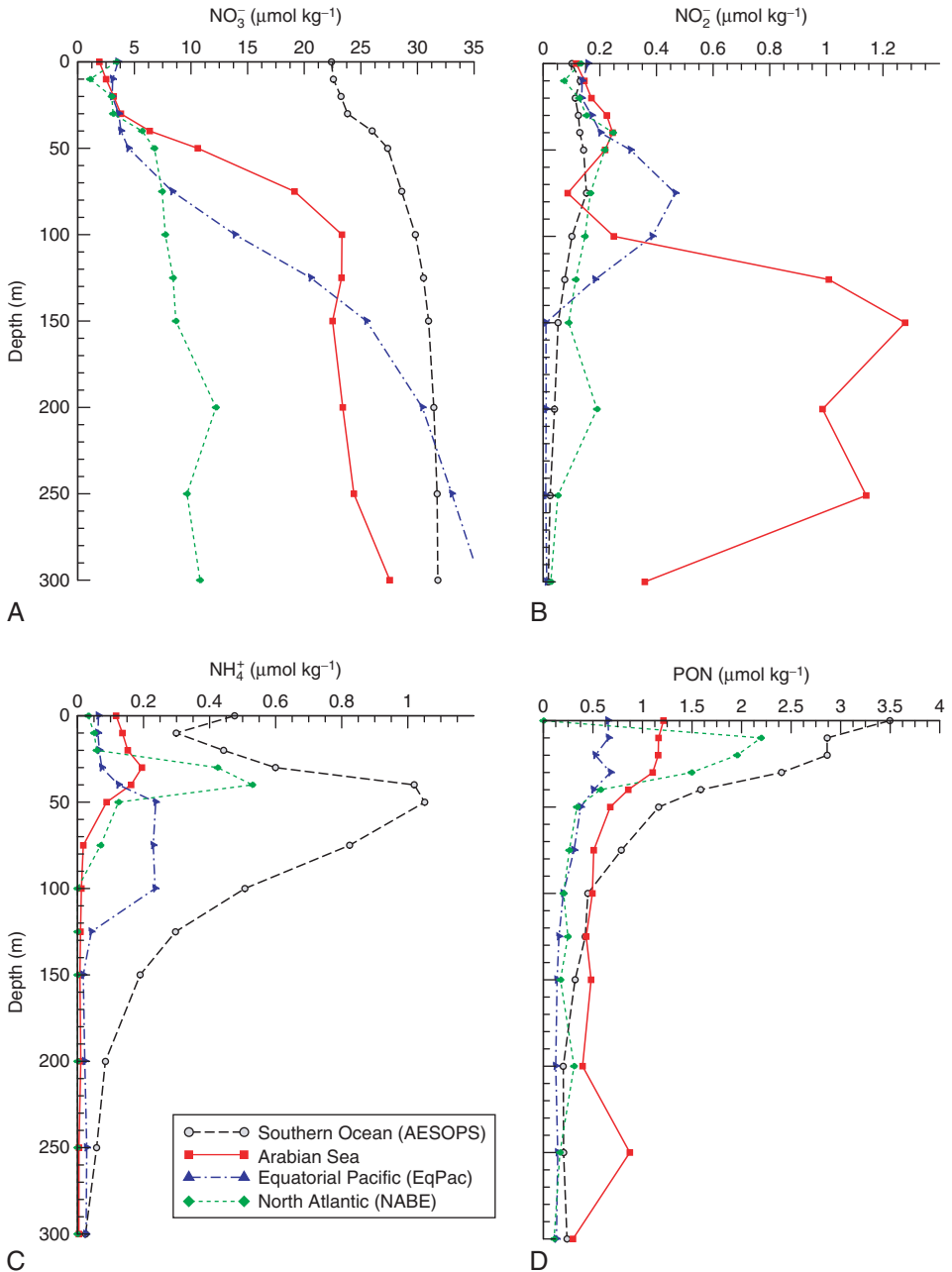

Figure 1.7 Average vertical profiles of (A) NO_3^- , (B) NO_2^- , (C) NH_4^+ , and (d) PON from the four JGOFS process studies sites, i.e., Southern Ocean in 1996–1998 (80°S – 51°S ; 160°E – 161°W), Arabian Sea in 1995 (8°N – 26°N ; 54°E – 71°E), Equatorial Pacific in 1992 (146°W – 135°W ; 13°S – 12°N), and North Atlantic in 1989 (41°N – 59°N ; 25°W – 17°W). Data were obtained from usjgofs.whoi.edu and were averaged for each study without consideration of exact location or season.

The mid-depth maximum of NH_4^+ observed in the mean profile (Fig. 1.3) exists in all four regions, but occurs with different strengths and at different depths. As was the case above, small differences in production or consumption, such as arising from differences in productivity, depth of the euphotic zone, light, and PON availability likely determine the exact shape of the profile.

3.3.2. New versus regenerated production

Arguably, the concept of *new versus regenerated production* has been among the most important paradigms guiding biological and biogeochemical oceanography in the last two decades (Ducklow, 1995; Ducklow *et al.*, 2001; Falkowski *et al.*, 2003; Karl *et al.*, in Chapter 16, this volume). As introduced by Dugdale and Goering (1967), new production refers to that part of primary production that is fueled by nutrients inputs from outside the euphotic zone. Regenerated production is the remainder, i.e., that part of production that is based on inorganic nutrients that are recycled from organic matter within the euphotic zone.

There are two reasons why this paradigm has become so important: First, in steady-state, and if averaged over sufficiently long spatial and temporal scales (see e.g., Williams *et al.* (1989) and Plattner *et al.* (2005)), new production can be equated with export production, i.e., the flux of organic carbon and nutrient elements out of the euphotic zone (Fig. 1.8) (Eppley and Peterson, 1979). Since it is the magnitude

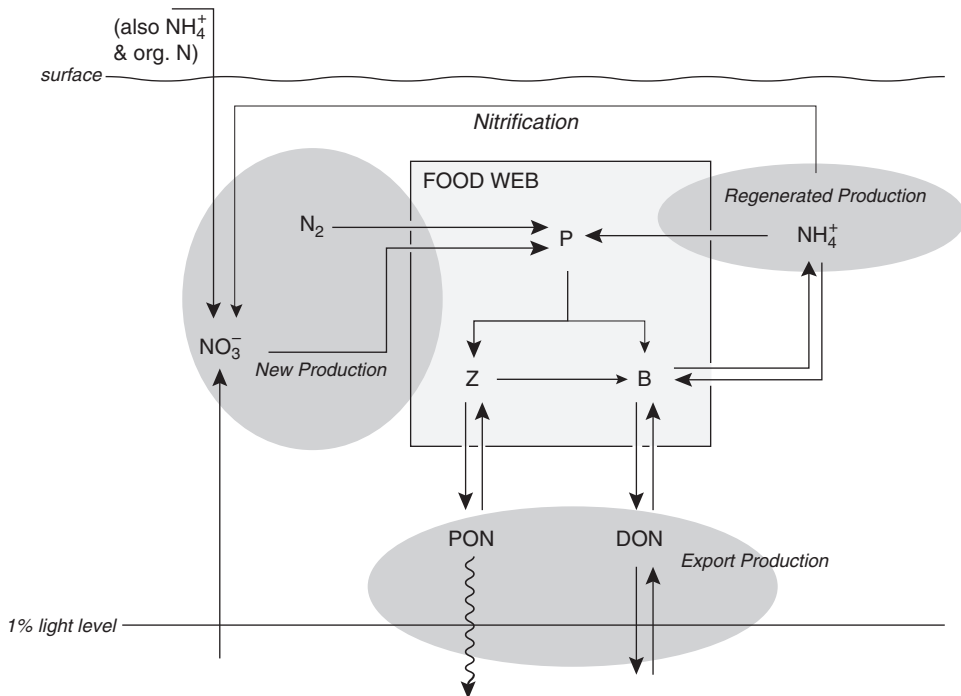

Figure 1.8 Schematic illustration of the nitrogen cycling paradigm in the euphotic zone. Adapted from Sarmiento and Gruber (2006).

of export production and not primary production that determines the efficiency of the biological pump, and it is the latter that determines the impact of biology on atmospheric CO₂, estimating export production has been a primary focus of biogeochemical research (Ducklow *et al.*, 2001). However, export production is notoriously difficult to measure (see e.g., Buesseler *et al.* (2007) for a discussion of sediment traps), so using estimates of new production as a proxy for export production is attractive (Brix *et al.*, 2006; Neuer *et al.*, 2002).

The second reason for the success of the new production paradigm is that new production is relatively easy to measure. This is because new production in the open ocean is usually associated with the uptake of NO₃⁻, while regenerated production is associated with the uptake of NH₄⁺. This remarkable fact is a direct consequence of nitrification being inhibited by light. As a result, NH₄⁺ that is created by ammonification in the euphotic zone is usually taken up again by phytoplankton rather than nitrified to NO₃⁻. In contrast, nearly all NH₄⁺ created in the aphotic zone is nitrified to NO₃⁻, so that fixed nitrogen that is supplied back to the euphotic zone from the ocean's interior is almost exclusively in the form of NO₃⁻. Recognizing the chemical distinction between nitrogen following either the new or the regenerated production pathways, Dugdale and Goering (1967) demonstrated that one can use ¹⁵N labeled NO₃⁻ and NH₄⁺ in incubation experiments together with ¹⁴C labeled CO₂ to determine the fraction of primary production that is caused by either new or regenerated production.

This method has been widely adopted and has not changed much conceptually since its inception. Due to need to spike the phytoplankton sample with NO₃⁻, the method is problematic to use in oligotrophic gyres (Falkowski *et al.*, 2003). As a result, it has been applied primarily in HNLC regions (e.g., Aufdenkampe *et al.* (2001)) and in more productive coastal or high-latitude regions (e.g., Wilkerson *et al.* (1987)). Many insights have been gained from these measurements, permitting to develop models of what controls the ratio of new or export production to primary production (see e.g., Laws *et al.* (2000) for a summary of results and a model of this ratio).

Although recognized from the very beginning that equating NO₃⁻ uptake with new production is only correct if other processes such as N₂ fixation, atmospheric deposition, or river input are negligible (Dugdale and Goering, 1967), this caveat has been ignored often. This was done because of either experimental limitations or lacking evidence that the other nitrogen supply pathways were substantial. However, research over the last two decades has revealed that atmospheric deposition, river fluxes, or N₂ fixation supplies in many regions a substantial amount of fixed nitrogen to the upper ocean, in some cases equaling or exceeding the classical vertical transport pathway (Capone *et al.*, 2005). Phytoplankton have been identified that can migrate vertically over substantial distances in order to take up excess fixed nitrogen at depth and then float to the surface to undertake photosynthesis (Villareal *et al.*, 1993), providing a novel pathway of introducing new nitrogen into the system. In addition, increasing evidence exists that nitrification occurs within the euphotic zone (Ward *et al.*, 1989; Zehr and Ward, 2002), and that organic nitrogen can be released and taken up by phytoplankton (Bronk *et al.*, 1994), further blurring the association of NH₄⁺ uptake with regenerated production and the uptake of NO₃⁻ with new production. Nevertheless, the paradigm of new versus regenerated production remains a powerful concept to understand upper ocean biogeochemical cycles.

3.4. Nitrite

Since the commonly used colorimetric method to measure NO_3^- involves the reduction to NO_2^- , the latter is usually measured separately as well, so that the $\text{NO}_3^- + \text{NO}_2^-$ measurements can be corrected for NO_2^- . As a result, there are nearly as many measurements of NO_2^- as there are of NO_3^- . However, many of these samples have NO_2^- concentrations below the relatively high detection level. In addition, the colorimetric method is not very accurate at low concentrations, so that special low-level methods are required to study nitrite dynamics (Brzezinski, 1988; Dore and Karl, 1996; Lipschultz *et al.*, 1996; Zafriou *et al.*, 1992).

The turnover time of NO_2^- is not well known, but has been estimated to be about 3–7 days (Lipschultz *et al.*, 1996). This makes NO_2^- the shortest lived among the nitrogen species considered here. The main reason for this fast turnover is that NO_2^- , even more so than NH_4^+ , represents an intermediary species (Figure 1.2). It is produced during NO_3^- assimilation, nitrification, and denitrification, and then immediately consumed again.

The interaction of these processes explains the ocean mean distribution shown in Fig. 1.3, as well as the distribution observed during the four U.S. led JGOFS process studies (Fig. 1.7). In general, the NO_2^- distribution in the euphotic zone appears to follow roughly that of NH_4^+ , except that its mean concentration is slightly smaller, on average. While the correspondence of NH_4^+ and NO_2^- in the euphotic zone suggests that NO_2^- there is mostly controlled by nitrification (Ward *et al.*, 1982), some of the deeper NO_2^- may reflect also its generation during the assimilation of NO_3^- . This is supported by the observation that elevated concentrations of NO_2^- are often associated with the nitracline, i.e., the first appearance of elevated NO_3^- concentrations in the water column (Dore and Karl, 1996; Herbrand and Voituriez, 1979) (see e.g., Fig. 1.9).

The correlation of NO_2^- and NH_4^+ concentrations often breaks apart below the euphotic zone. This is particularly the case in oxygen minimum zones, where a secondary NO_2^- peak is frequently observed (see Fig. 1.7 and Codispoti and Christensen (1985)). In the Arabian Sea, NO_2^- concentrations exceed $1 \mu\text{mol kg}^{-1}$ between about 100 m and 500 m (Fig. 1.7). A similar secondary NO_2^- peak can be observed between 250 m and 500 m in the eastern Tropical Pacific (Fig. 1.9b) (Codispoti, 1983; Codispoti and Christensen, 1985; Codispoti and Packard, 1980). This secondary NO_2^- peak can be attributed to denitrification, as it occurs in association with a well developed anoxic region at mid-depths in the eastern tropical North Pacific (see Fig. 1.9c). A closer inspection shows that the NO_2^- maximum often occurs outside the region of strongest anoxia, i.e., at O_2 concentrations between 1 and $5 \mu\text{mol kg}^{-1}$ (see e.g., Codispoti *et al.* (1986) and Codispoti and Christensen (1985)). This location of the secondary NO_2^- maximum is usually interpreted as reflecting the superposition of NO_2^- formation by (aerobic) nitrification, and NO_2^- formation by (anaerobic) denitrification (e.g., Yakushev and Neretin (1997)) both of which can co-occur at these very low, but non-zero O_2 concentrations (Morrison *et al.*, 1999). In contrast, inside the oxygen minimum zone, NO_2^- is very efficiently reduced further to N_2 , preventing it from accumulating there. There exist more subtle reasons, involving, for example, trace metal limitations of the nitrite oxidizers at these very low oxygen concentrations (Granger and Ward, 2003).

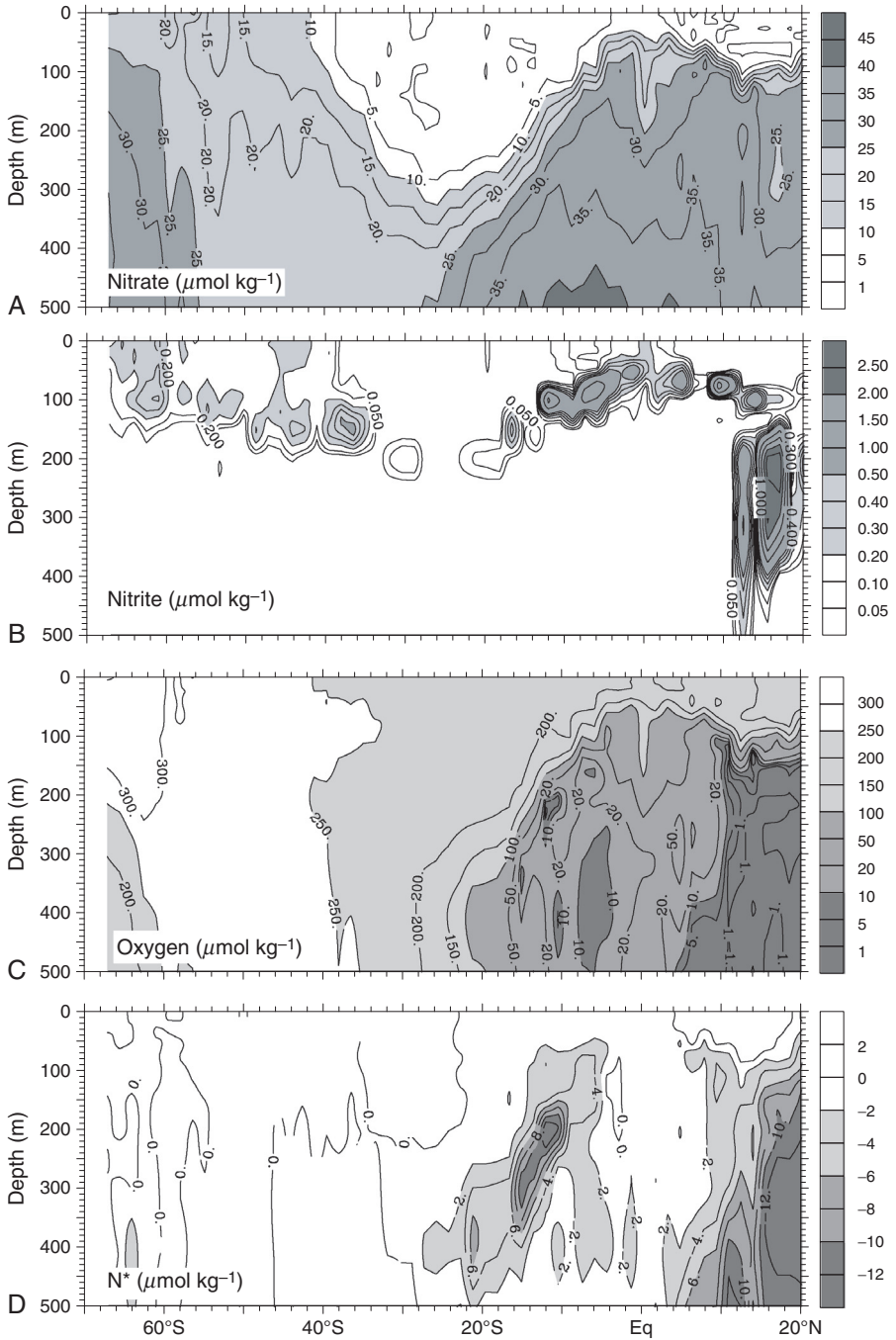

Figure 1.9 Meridional sections of (A) NO_3^- , (B) NO_2^- , (C) oxygen, and (D) N^* along about 100°W in the eastern Pacific. Data are from the WOCE cruise P18 conducted in 1994 (whpo.ucsd.edu).

3.5. Organic nitrogen

More than 99% of the organic nitrogen in the ocean exists in the form of dissolved organic nitrogen, *DON* (see Table 1.2). Only a small fraction of it is chemically characterized, reflecting the large number of organic molecules that contain nitrogen groups. I will not elaborate further on *DON* as it is discussed in detail by *Aluwihare and Meador* in Chapter 3, this volume (see also Bronk (2002)). I therefore limit my discussion to particulate organic nitrogen, *PON*.

PON represents only about 0.5% of the total organic nitrogen pool, but since some of the *PON* is heavy enough to sink, it represents a crucial component of the marine biological pump. Its mean turnover time is only about 2 weeks (see Table 1.2), reflecting the rapid synthesis and degradation of *PON*. In the euphotic zone, most of the POC is believed to be living matter, although the composition of *PON* is not well characterized. *PON* exists in size across several orders of magnitude, ranging from very fine suspended particles to large aggregates, such as marine snow or fecal pellets.

Figure 1.7d shows a summary of *PON* measurements from the four JGOFS process studies. In most cases, *PON* is highest near the surface and decreases quasi-exponentially with depth. There exist large differences in the mean concentrations between the different JGOFS process studies, with *PON* concentrations during the Southern Ocean experiment reaching above $3 \mu\text{mol kg}^{-1}$, on average, while *PON* barely exceeds $0.5 \mu\text{mol kg}^{-1}$ in the Equatorial Pacific. The depth distribution within the euphotic zone as well as the spatial differences largely reflect variations in living biomass (mostly phytoplankton). For example, the Southern Ocean JGOFS program targeted spring blooms in the Southern Ocean, during which very high concentrations of phytoplankton can be reached (Smith *et al.*, 2000).

Below about 200 m, *PON* concentrations tend to asymptote to similar levels of about 0.1 to $0.3 \mu\text{mol kg}^{-1}$, irrespective of the large differences in *PON* in the euphotic zone. Overall, *PON* dynamics in the aphotic zone tends to follow that of particulate organic carbon (*POC*), with a stoichiometric C:N ratio of about 7.1 ± 0.1 (equivalent to $16:114 \pm 2$) for the particles sinking out of the euphotic zone (Schneider *et al.*, 2003) (see also Hebel and Karl (2001) for long-term observations of the *POC* and *PON* dynamics in an oligotrophic environment). In their analysis of sediment trap samples and particles collected by *in situ* pumps, Schneider *et al.* (2003) also noticed a slight increase of this ratio with depth of about 0.2 per 1000 m, so that particles sinking across 1000 m have a C:N ratio very close to the 117:16 ratio proposed by Anderson and Sarmiento (1994).

3.6. Nitrogen*: The imprint of N_2 -fixation and denitrification

A remarkable observation from Fig. 1.6a is not only the strong co-variation of NO_3^- with PO_4^{3-} with a slope of about 16:1, but also the near-zero intercept of the mean trendline. While the existence of a well defined slope is not surprising since it reflects the mean stoichiometry of organic matter synthesis and remineralization (reactions 1.1 through 1.5), the reasons for the existence of a near-zero intercept are less obvious. Generally, this near-zero intercept is interpreted as evidence for the

existence of a stabilizing feedback between N_2 fixation and denitrification, which is controlled by the oceanic ratio of NO_3^- to PO_4^{3-} (Gruber, 2004; Redfield, 1958; Tyrrell, 1999) (see discussion below).

A convenient way to analyze the impact of N_2 fixation and denitrification on the oceanic NO_3^- distribution is to remove the photosynthesis/remineralization trend of 16:1, and focus instead on the anomalies from this trend. This is achieved by defining a linear combination of the two nutrients, i.e.,

$$N^* = [NO_3^-] - 16[PO_4^{3-}] + 2.9\mu\text{mol kg}^{-1} \quad (1.10)$$

where the constant of $2.9\mu\text{mol kg}^{-1}$ was added to obtain a global mean N^* of zero (see Gruber and Sarmiento, (1997, 2002) for an in depth derivation and a discussion of caveats). More recently, Hansell *et al.* (2004) introduced the tracer “excess DIN” (DIN_{xs}) based on the same concept. In fact, DIN_{xs} is identical to N^* except that Hansell *et al.* (2004) set the constant to zero, i.e., $DIN_{xs} = N^* - 2.9\mu\text{mol kg}^{-1}$.

As illustrated in Fig. 1.10a, N^* is constant for any line with a slope of 16:1 and represents a measure of the distance between any NO_3^- and PO_4^{3-} pair and the mean oceanic trend line.

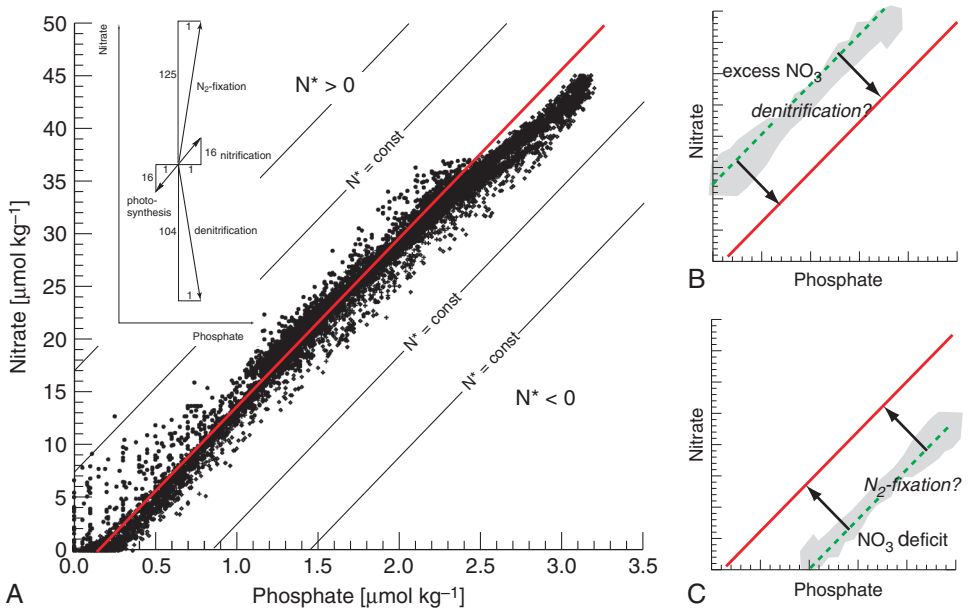

Figure 1.10 (A) Plot of NO_3^- versus PO_4^{3-} from all depths and from selected WOCE cruises in all ocean basins (A16,P16,I8NI9S). The inset shows how the various processes influence the NO_3^- versus PO_4^{3-} distribution. The solid line represents the mean ocean trend with a slope of 16:1, while the thinner lines show trends of constant N^* (see text for definition). (B) Hypothetical distribution of NO_3^- versus PO_4^{3-} in a situation of excess NO_3^- . (C) as (B), except for a situation of a NO_3^- deficit. It is unclear why the intercept of the mean oceanic trendline in (A) is so close to zero. From Gruber (2004).

The strength of the N^* concept is that it represents the time and space integrated impact of N_2 fixation and denitrification on the oceanic nutrient fields, which is attractive given the fact that direct rate measurements of N_2 fixation and denitrification are difficult, time-consuming, and generally very sparse (see Chapter 4 by *Carpenter and Capone* and Chapter 6 by *Devol*). A drawback is that N^* cannot distinguish between N_2 fixation and denitrification as it represents the sum of these two processes. However, the interpretation is greatly aided by the fact that these two processes are often spatially and temporally separated. In addition, concurrent analyses of the isotopic $^{14}N/^{15}N$ ratio can also help to disentangle the various processes that lead to variations in N^* (*Gruber, 2004; Sigman et al., 2003, 2005*). *Figure 1.11* shows the distribution of N^* along the same global section used before for NO_3^- (cf *Fig. 1.5*). N^* concentrations are highest in the North Atlantic and tend to decrease gradually toward the Pacific. This implies a net transport of fixed nitrogen from the Atlantic into the Pacific, suggesting that, from a global perspective, the North Atlantic acts as a net source of fixed nitrogen for the world ocean, while the Pacific acts as a net sink. This does not imply, however, that N_2 fixation in the Atlantic is higher than in the Pacific. It just implies that the balance of N_2 fixation and denitrification is positive in the Atlantic and negative in the Pacific.

Global maps of N^* on two isopycnal surfaces ($\sigma_\theta = 26.50$, representing subtropical mode waters (mean depth of about 300 m) and $\sigma_\theta = 27.10$, representing subpolar mode waters) reveal that the N^* minima seen in the thermocline of the Pacific (*Figures 1.9 and 1.11*) are part of a large-scale pattern extending over much of the eastern tropical Pacific (*Figure 1.12*). On the $\sigma_\theta = 26.50$ surface, the N^* minimum is well separated into an Eastern Tropical South Pacific (ETSP) and into an Eastern Tropical North Pacific (ETNP) part with a local N^* maximum in between (seen also in the P18 section (*Fig. 1.9d*)). On the deeper surface ($\sigma_\theta = 27.10$), the N^* minimum

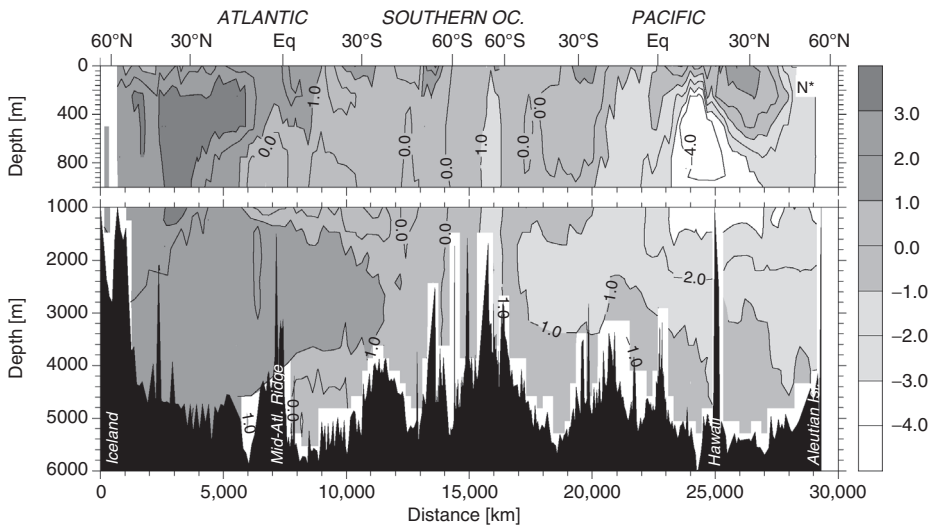

Figure 1.11 As *Fig. 1.5*, except for N^* ($\mu\text{mol kg}^{-1}$).

in the ETSP has lost much of its characteristics, while the minimum in the ETNP remains well defined. Finally, the maps reveal an additional minimum of N^* in the Arabian Sea.

A more detailed inspection of the N^* maximum in the subtropical North Atlantic (Fig. 1.12) reveals that the concentration of N^* increases as waters move

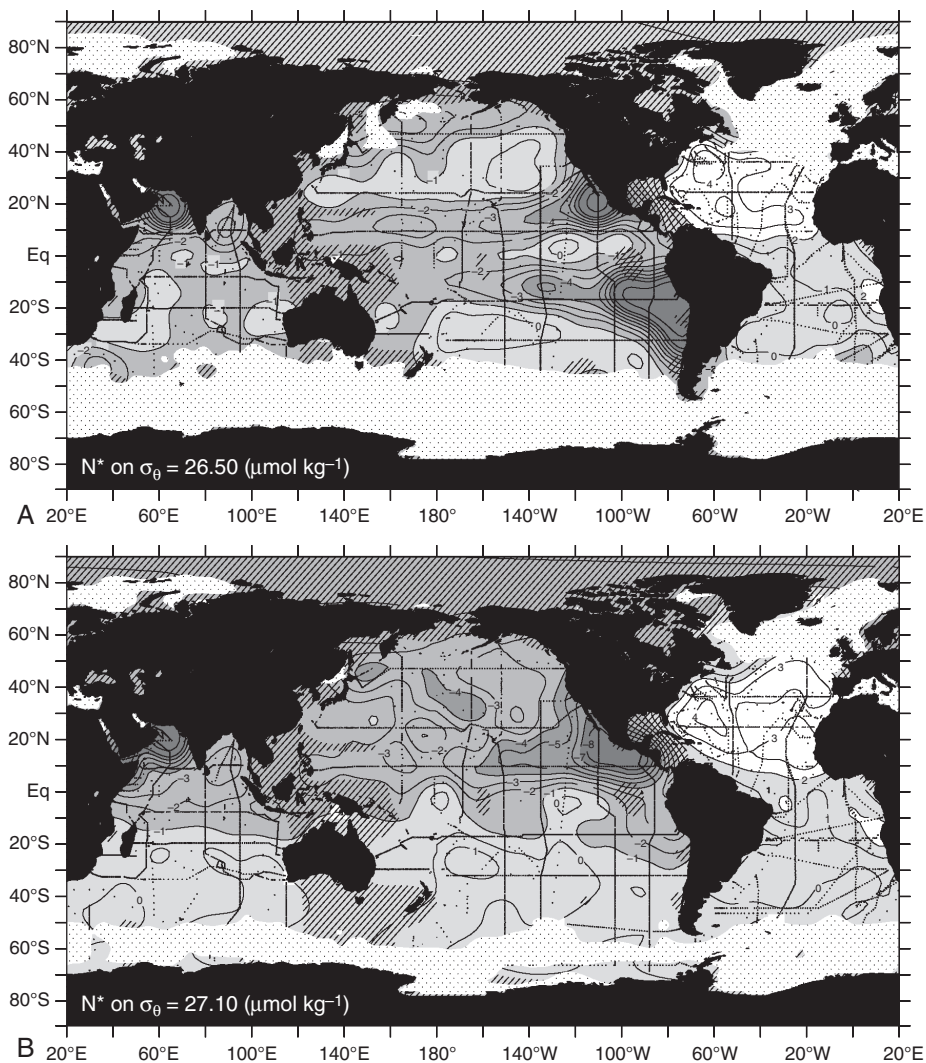

Figure 1.12 Global plots of objectively analyzed N^* ($\mu\text{mol kg}^{-1}$) on isopycnal surfaces. (A) N^* on the $\sigma_\theta = 26.50$ surface. This surface is characteristic of subtropical mode waters, such as the 18° Water in the North Atlantic, (B) N^* on the $\sigma_\theta = 27.10$ surface representing Subpolar Mode Waters. Solid circles denote the stations; stippling denotes areas where the waters of this potential density are not present in winter time. Cross-hatched areas are regions where the estimated error in objectively analyzed N^* is greater than $0.7 \mu\text{mol kg}^{-1}$. Data are from the WOCE program augmented by selected pre-WOCE cruises and were adjusted by the GLODAP project.

from the outcrop region in the northeastern part of the gyre toward the southwest. This pattern of ingrowth of N^* was combined with information about the ventilation rate of different water masses to arrive at geochemically-based estimates of N_2 fixation (Gruber and Sarmiento, 1997; Hansell *et al.*, 2004; Michaels *et al.*, 1996). These studies inferred rather divergent N_2 fixation estimates for the entire North Atlantic (see discussion by Hansell and Follows, Chapter 13, this volume), although a new analysis using nitrogen-15 abundance in organic nitrogen by Capone *et al.* (2005) suggests an intermediate value close to that proposed by Gruber and Sarmiento (1997). This suggestion is also supported by the uncovering of a much larger abundance of *Trichodesmium* in the subtropical North Atlantic than previously observed (Davis and McGillicuddy, 2006).

Interpretation of the N^* distribution in the Pacific and Indian oceans is more difficult because of the existence of strong denitrification sites adjacent to the places where one expects to find the N_2 fixation signals. In the subtropical North Pacific, where N_2 fixation is well documented (Karl *et al.*, 1997), the N^* maximum exists just near the surface and does not extend into the thermocline as is the case in the subtropical North Atlantic. This is likely a result of the eroding effect by waters that obtain extremely low N^* values in the eastern Pacific and are then advected westwards in the main thermocline (Fig. 1.12).

The strong N^* minima in the ETNP and ETSP (Figures 1.11 and 1.12) reflect mostly the intense water column denitrification that occurs in these two oxygen minimum regions (Fig. 1.13) (Codispoti and Packard, 1980; Codispoti and Richards, 1976; Hattori, 1983), although benthic denitrification may contribute as well. The two N^* minima have long tails that reach far westward into the central Pacific. The shape and position of these tails, together with their O_2 concentrations well above the critical O_2 concentration for the onset of denitrification (Fig. 1.13) suggests that these features are the result of westward advection of the N^* signals in the North and South Equatorial currents and do not reflect *in situ* water column denitrification. These waters slowly lose their signature as they mix with eastward moving waters in the equatorial undercurrent system and as they entrain subtropical waters, both having elevated N^* concentrations. A region of reduced N^* concentrations extends from the ETNP also northward along the American western margin. While most of this signal is thought to reflect the northward advection of low N^* waters from the ETNP in the California Undercurrent (Castro *et al.*, 2001), these waters likely incorporate N^* signals from benthic denitrification (Christensen *et al.*, 1987; Devol and Christensen, 1993) or Anammox (Dalsgaard *et al.*, 2003) along the margin as well. These benthic processes explain also many of the low N^* values found in the North Pacific and elsewhere along the continental margins.

In the Indian Ocean, near surface values of N^* are slightly elevated (Gruber and Sarmiento, 1997). As these elevated values are located just above some of the lowest N^* values found anywhere in the world oceans, they suggest rather strong N_2 fixation. Observations of *Trichodesmium* abundance (Carpenter, 1983) and a few direct rate measurements (reported in Capone *et al.* (1997)) support this conclusion. The low N^* concentrations in the thermocline of the Arabian Sea (Fig. 1.12)

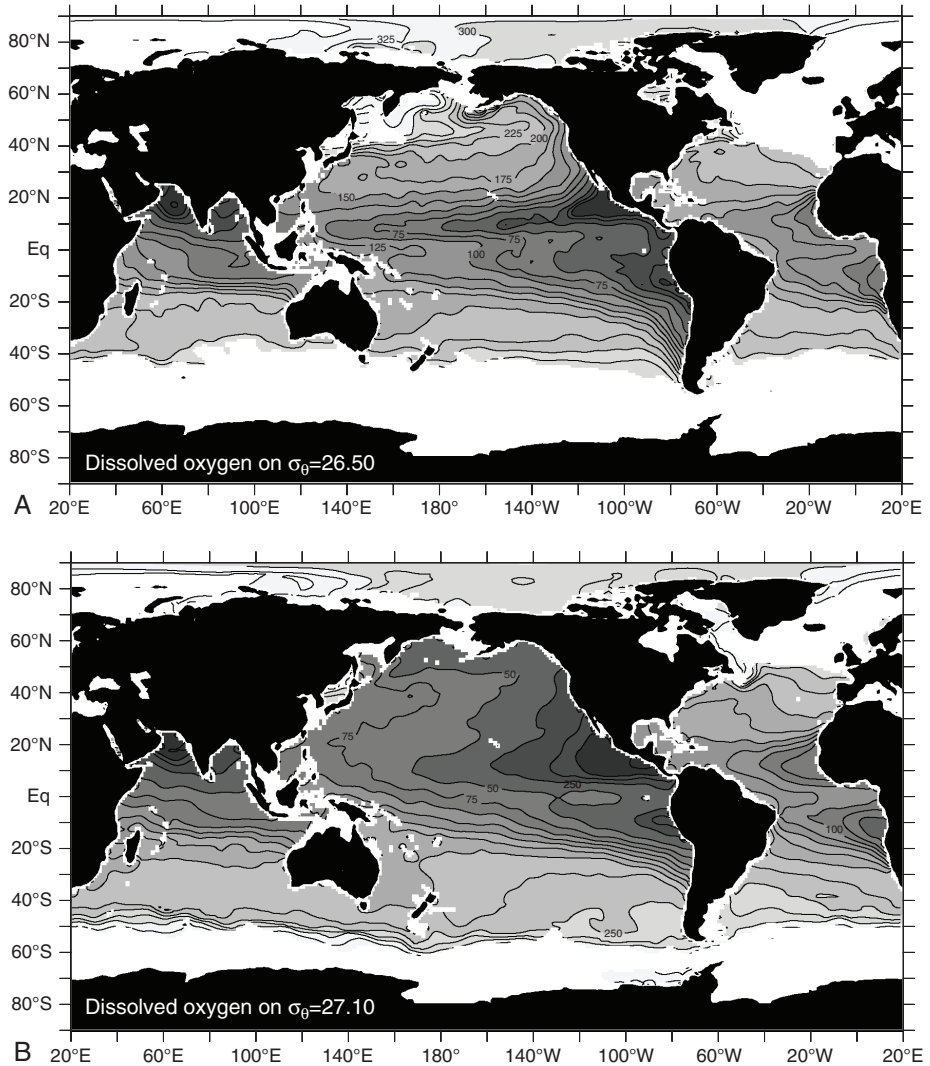

Figure 1.13 Global plots of oxygen ($\mu\text{mol kg}^{-1}$) on (A) the $\sigma_\theta = 26.50$ surface and on (B) the $\sigma_\theta = 27.10$ surface. Based on data from the World Ocean Atlas (Conkright *et al.*, 2002).

coincide with another well known oxygen minimum zone (Fig. 1.13) with high rates of water column denitrification (Mantoura *et al.*, 1993; Naqvi, 1987; Naqvi *et al.*, 1982; Naqvi, Chapter 14, this volume). Low concentrations of N^* are also found in the Bay of Bengal, but they likely reflect an advective signal from the Arabian Sea and from the shelf sediments rather than water-column denitrification within the Bay of Bengal itself (Gruber and Sarmiento, 1997).

4. BUDGETS

4.1. Oceanic nitrogen budget

Figure 1.14 depicts a summary of the current oceanic nitrogen budget, obtained by combining the fixed nitrogen budget of Gruber (2004) with an organic nitrogen budget derived from an organic carbon budget by Sarmiento and Gruber (2006) assuming a constant C:N ratio in organic matter. The budget is shown separately for the coastal/margin and the open ocean environments, where the former is defined as all regions shallower than 1000 m. The numbers shown are central estimates and in most cases contain uncertainties of at least $\pm 30\%$.

From a quantitative perspective, the most important process of the fixed nitrogen cycle in the ocean is the assimilation of NO_3^- and NH_4^+ into organic nitrogen in the

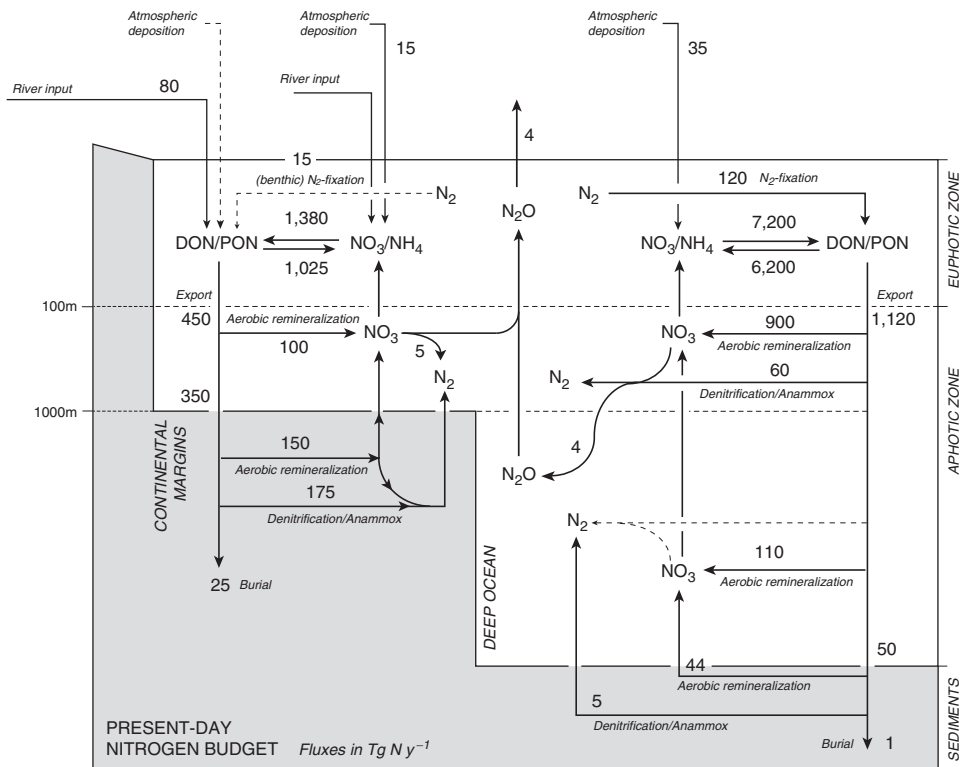

Figure 1.14 Schematic budget of the present-day (*ca.* AD 1990) marine nitrogen cycle. All fluxes are in units of Tg N year^{-1} . The budget is based on the marine organic carbon budget of Sarmiento and Gruber (2006) (their Fig. 6.5.2) and the fixed marine nitrogen budget of Gruber (2004) given in Table 1.3. A stoichiometric C:N ratio of 7.3 (Anderson and Sarmiento, 1994; Schneider *et al.*, 2003) was assumed when converting the organic carbon fluxes to organic nitrogen fluxes. Ill constrained fluxes were computed by difference, assuming a balanced budget. The level of uncertainty varies strongly between the individual fluxes, but is usually of the order of $\pm 30\%$ (see Table 1.3).

euphotic zone, resulting in the fixation of over ~ 7000 Tg N year⁻¹ in the open ocean, and another ~ 1400 Tg N year⁻¹ in the coastal/margin environments. As is the case for organic carbon, of the order of 20% of the organic nitrogen formed in the euphotic zone is lost to the ocean's interior, resulting in export fluxes of organic nitrogen of the order of ~ 1100 Tg N year⁻¹ in the open ocean, and about ~ 450 Tg N year⁻¹ in the coastal/margin environments. In the open ocean, nearly all of this exported organic nitrogen is nitrified back to NO_3^- in the water column, leading to a very small deposition flux of organic nitrogen to the seafloor (about 50 Tg N year⁻¹). In contrast, the majority of the exported organic nitrogen reaches the seafloor in the margin/coastal environments, leading to a deposition flux of ~ 350 Tg N year⁻¹.

In the open ocean, the low fluxes of organic matter to the seafloor seldom cause anoxic conditions in the near-surface sediments, so that the majority of the 50 Tg N year⁻¹ deposited on the seafloor is nitrified, and only a very small fraction is denitrified (~ 5 Tg N year⁻¹). This contrasts dramatically with the coastal/margin environment, where the high flux of organic carbon drives much of the sediments in this region anoxic, favoring denitrification and/or anammox over aerobic remineralization of the organic nitrogen. The exact magnitude of benthic denitrification is not well established with estimates reaching values as high as 300 Tg N year⁻¹ (Codispoti *et al.*, 2001) (Table 1.3). I adopt here the estimate of Gruber (2004) of 180 Tg N year⁻¹, which is similar to that used by Galloway *et al.* (2004) and is supported by the recent estimate of 190 Tg N year⁻¹ by Deutsch *et al.* (2004).

Table 1.3 Present-day (ca 1990) Global marine nitrogen budgets of Codispoti *et al.* (2001), Gruber (2004), and Galloway *et al.* (2004)

| Process | Codispoti <i>et al.</i> ^a | Galloway <i>et al.</i> ^{a,b} | Gruber ^a |
|-------------------------------------|--------------------------------------|---|---------------------|
| | | <i>Sources</i> (Tg N yr ⁻¹) | |
| Pelagic N ₂ fixation | 117 | 106 | 120 ± 50 |
| Benthic N ₂ fixation | 15 | 15 | 15 ± 10 |
| River input (DON) | 34 | 18 ^c | 35 ± 10 |
| River input (PON) | 42 | 30 ^c | 45 ± 10 |
| Atmospheric deposition | 86 | 33 | 50 ± 20 |
| Total sources | 294 | 202 | 265 ± 55 |
| | | <i>Sinks</i> (Tg N yr ⁻¹) | |
| Organic N export | 1 | | 1 |
| Benthic denitrification | 300 | 206 | 180 ± 50 |
| Water column denitrification | 150 | 116 | 65 ± 20 |
| Sediment Burial | 25 | 16 | 25 ± 10 |
| N ₂ O loss to atmosphere | 6 | 4 | 4 ± 2 |
| Total sinks | 482 | 342 | 275 ± 55 |

^a See the original publications for details, i.e. Galloway *et al.* (2004), Codispoti *et al.* (2001), and Gruber (2004).

^b Listed are the central values reported by Galloway *et al.* (2004) (see Table 1 and Fig. 1 of their publication).

^c Galloway *et al.* (2004) lists only the total river flux. I assumed that about two thirds of the total is PON, and one third is DON.

Subtracting the small amount of benthic denitrification in the open ocean (~ 5 Tg N year⁻¹), leads to a coastal/margin benthic denitrification flux estimate of ~ 175 Tg N year⁻¹. Assuming that the influx of NO_3^- into the sediments from the overlying bottom water is small, this means that about 50% of the organic nitrogen being deposited on the seafloor in the margin/coastal environments is denitrified. 25 Tg N year⁻¹ is buried, which implies that about 150 Tg N year⁻¹ or about 43% of the deposited organic nitrogen is undergoing aerobic oxidation to nitrate (nitrification). The benthic denitrification estimate of Codispoti *et al.* (2001) of 300 Tg N year⁻¹ would mean that nearly 90% of the nitrogen deposited on the seafloor was denitrified, leaving only 25 Tg N year⁻¹ for nitrification. Considering that a substantial fraction of the bottom waters overlying the sediments in the margin/coastal environments are oxygenated, such a small role for nitrification is difficult to imagine. However, the presently available data are insufficient to reject either estimate.

Water column denitrification represents the second most important loss process for fixed nitrogen. Current rate estimates diverge quite substantially (see Table 1.3), with estimates as high as 150 Tg N year⁻¹. I adopted here the estimate by Gruber (2004) of 65 Tg N year⁻¹, which is at the low end of the current range of estimates, but satisfies the nitrogen-15 mass balance constraint of an approximately 3:1 ratio between benthic and water-column denitrification (Brandes and Devol, 2002). It is also in good agreement with the recent estimate of 70 Tg N year⁻¹ by Deutsch *et al.* (2004). I assume that the majority of the water column denitrification occurs in the open ocean, such as the eastern Tropical Pacific and the Arabian Sea. The formation and subsequent loss of N_2O represents another loss term. Although its magnitude is small (about 4 Tg N year⁻¹), this flux is important when considering the atmospheric N_2O budget, as it represents about a third to half of the estimated pre-industrial N_2O sources to the atmosphere (Prather *et al.*, 2001; see also Chapter 2 by Bange, this volume).

These fixed nitrogen losses add up to more than 300 Tg N year⁻¹ (Table 1.3). Without processes supplying fixed nitrogen to the ocean, these losses would lead to a complete exhaustion of all fixed nitrogen in the ocean within about 2000 years. Atmospheric deposition of fixed nitrogen is estimated to be about 50 Tg N year⁻¹ (Duce *et al.*, 2008) and rivers add another 80 Tg N year⁻¹ to the ocean (see Seitzinger and Harrison in Chapter 9, this volume, for a more thorough discussion of nitrogen fluxes by rivers). The largest source of fixed nitrogen to the ocean is N_2 fixation, however. Over the last two decades, estimates of the magnitude of global pelagic N_2 fixation have increased dramatically, but most recent estimates converge around 100 to 150 Tg N year⁻¹ (Table 1.3) (Gruber, 2004; Gruber and Sarmiento, 1997; Galloway *et al.*, 2004; Deutsch *et al.*, 2007). It is presently not well established how much of this global N_2 fixation occurs in the coastal/margin environment, although the canonical view is that most of it occurs in the open ocean, where conditions are usually more conducive for *Trichodesmium*, i.e., high temperatures, high vertical stability, and low NO_3^- concentrations (Karl *et al.*, 2002). However, recent observations in the Southern California Bight suggest also substantial rates of N_2 fixation in a coastal setting, particularly during the nutrient depleted, well stratified summer period (A. Leinweber and D. Capone, personal communication, 2006). Benthic environments add another ~ 15 Tg N year⁻¹ to the ocean, primarily in very nearshore environments (Capone, 1983).

Adding these numbers together, a nearly balanced marine nitrogen budget emerges, albeit with very large uncertainties. A strongly differing view was recently taken by [Codispoti *et al.* \(2001\)](#), who suggested that the losses of fixed nitrogen were underestimated in the past by nearly a factor of two, leading to a marine nitrogen budget that may be out of balance by nearly 200 Tg N year⁻¹. These authors suggested that this may reflect the substantial alteration of the global nitrogen cycle by humans, and therefore may be a very recent phenomenon. [Galloway *et al.* \(2004\)](#) recently reviewed the global nitrogen budget and arrived at an oceanic fixed nitrogen budget that is in between that of [Codispoti *et al.* \(2001\)](#) and that of [Gruber \(2004\)](#) (see [Table 1.3](#)). [Galloway *et al.* \(2004\)](#) also provided direct estimates of the human perturbation fluxes, and identified that these account for about ~45 Tg N year⁻¹. Even when considering the substantial uncertainties with this estimate, this perturbation flux is much smaller than the imbalances in the marine nitrogen budgets of [Codispoti *et al.* \(2001\)](#) and [Galloway *et al.* \(2004\)](#). Therefore the human perturbation is unlikely the cause for the imbalance in the budget. The much more likely cause are uncertainties in the different terms of the budget, in particular the magnitude of benthic and water column denitrification. Therefore, a renewed focus on these two processes with the aim to reduce their uncertainties would provide currently the most efficient way to reduce uncertainties in the oceanic fixed nitrogen budget. However, regardless of these uncertainties, all budgets agree that the marine nitrogen cycle is very dynamic, with a residence time for fixed nitrogen of about 3000 years only (see [Table 1.2](#)). This contrasts with the residence time of PO₄³⁻ in the ocean, which is about 30,000 to 50,000 years ([Delaney, 1998](#)).

4.2. Global nitrogen budget

[Figure 1.15](#) shows the marine nitrogen cycle in the context of the global nitrogen cycle in preindustrial times as well as how it has changed since then. A first remarkable observation is that the ocean is the largest reservoir of fixed nitrogen on Earth, containing about 5 times more fixed nitrogen than the land biosphere, where most of it is stored in soils. The amount of fixed nitrogen in the atmosphere is tiny, reflecting the high reactivity of these nitrogen species in the atmosphere and their quick removal. A second remarkable observation is that biological N₂ fixation on land and in the ocean is of similar magnitude. Interestingly, the same is the case for primary production, where photosynthetic organisms in both the ocean and on land fix about the same amount of carbon each year ([Field *et al.*, 1998](#)). However, due the lower fixed nitrogen inventory of the land biosphere, the turnover times for fixed nitrogen on land is faster than that in the ocean. Contrasting the land and ocean further, the land acted in preindustrial times as a net source of fixed nitrogen, while the ocean acted as a net sink. On land, preindustrial N₂ fixation exceeds denitrification so that a certain fraction of the fixed nitrogen can be exported laterally by rivers to the ocean, where it permits oceanic denitrification and burial to exceed N₂ fixation. The ocean also receives fixed nitrogen from the atmosphere, some of which has been produced there from N₂ by lightning, and some of which is exported from the land through the atmosphere.

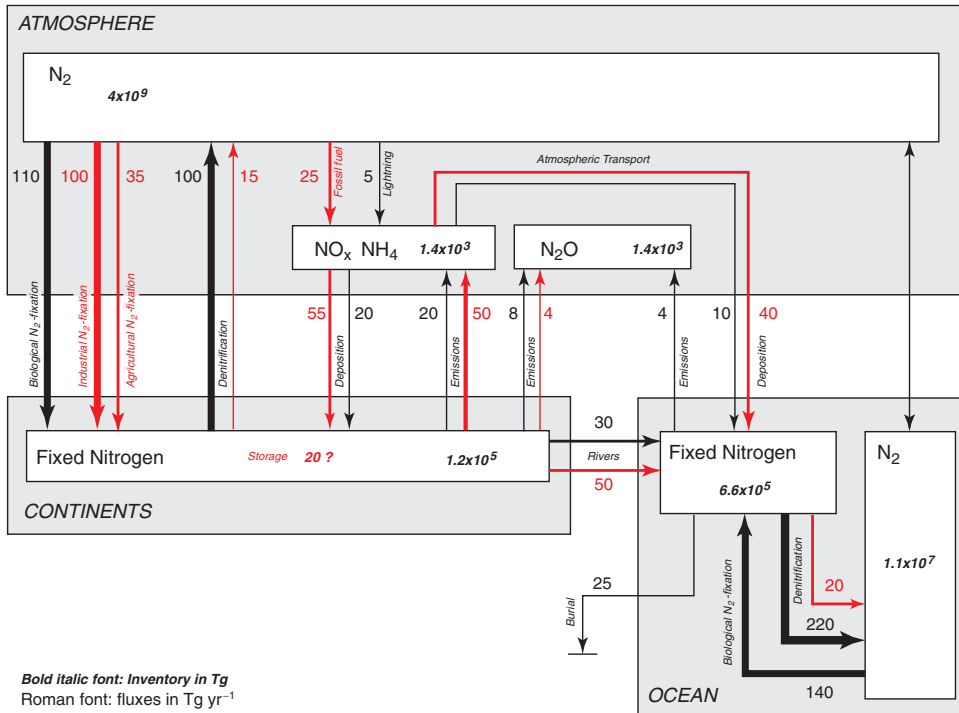

Figure 1.15 Schematic budget of the global nitrogen cycle in preindustrial times (black) and how it changed as a result of human intervention (red). Fluxes are in units of Tg N year⁻¹ and inventories (bold italics) in Tg N. The flux estimates are based on Gruber and Galloway (2008).

Over the last 250 years, humans have caused a massive perturbation of the global nitrogen cycle (see Galloway (1998) and below for more discussion), with most impact in terrestrial ecosystems. Industrial N₂ fixation by the Haber–Bosch process now rivals biological N₂ fixation by the land biosphere. Furthermore, the planting of legumes and other plants with endosymbiotic N₂ fixers has led to an additional input of fixed nitrogen to the land. Finally, the burning of fossil fuels leads to the generation of NO_x, most of which gets oxidized in the atmosphere to NO₃⁻ before being deposited on land. The combined anthropogenic inputs of fixed nitrogen into land ecosystems now exceeds the preindustrial net input by nearly 50%. Most of this anthropogenic nitrogen input into the land ecosystems is either stored there or is denitrified, but a substantial fraction gets exported to the ocean via rivers and atmosphere, leading to more than a doubling of the input of fixed nitrogen into the ocean. The fate of this anthropogenic nitrogen transported by rivers is denitrified in the lower parts of the estuaries and in the coastal ocean (Seitzinger and Kroeze, 1998; Galloway *et al.*, 2004). By contrast, much of the increased atmospheric deposition likely makes it further out into the ocean, possibly stimulating productivity there (Duce, 1986).

5. NITROGEN CHALLENGES

5.1. Controls on the marine fixed nitrogen content

On some timescale approaching the turnover time of fixed nitrogen in the ocean (i.e., about 2000 to 3000 years), nitrogen fixation and denitrification in the ocean must be coupled to each other, otherwise the marine fixed nitrogen content of the ocean would have undergone massive swings in the past, with large implications for marine productivity. There is little evidence in the geological record that such massive variations occurred (Sigman and Haug, 2003), suggesting that the coupling must be reasonably tight. This requires the existence of well developed negative feedbacks that prevent the growth of initial perturbations, such as induced, for example, by the large climate variations associated with the glacial-interglacial transitions in the last million years.

Two negative feedback processes have been proposed to stabilize the oceanic nitrogen cycle (see Fig. 1.16 and discussions by e.g., Tyrrell (1999), Deutsch *et al.* (2004), and Gruber (2004), see also Galbraith *et al.* in Chapter 34, this volume). The first feedback process is based on denitrification (Broecker and Peng, 1982; Codispoti, 1989). Suppose that denitrification became stronger in response to some environmental change. This would cause the fixed nitrogen content of the ocean to decrease relative to the PO_4^{3-} content, thereby tending to reduce the supply of fixed nitrogen to the surface ocean as well. This would result in a smaller export production, leading to a smaller oxygen demand in the thermocline and a smaller organic nitrogen deposition onto the marine sediments. Since these two processes are thought to control denitrification, their decrease would cause both column and benthic denitrification to decrease as well. This would reduce the initial perturbation, i.e., close the negative feedback loop.

The second feedback builds on N_2 fixation and the assumption that diazotrophic organisms can outcompete “normal” phytoplankton in situations of severe NO_3^- depletion but where PO_4^{3-} is still present (Karl *et al.*, 2002), but that diazotrophic organisms are otherwise at a disadvantage because of their slow growth. Therefore, if fixed nitrogen became scarce relative to PO_4^{3-} in the ocean, these surface regions characterized by residual PO_4^{3-} would expand, increasing the ecological niche for diazotrophic organisms. As a consequence, N_2 fixation would increase and add newly fixed nitrogen to the ocean. After a while, the resulting increase in fixed nitrogen would reduce the regions of PO_4^{3-} residuals, removing the competitive advantage of diazotrophs, and hence lowering N_2 fixation again. An equilibrium is reached when N_2 fixation is back in balance with denitrification. Haug *et al.* (1998) provided evidence that such a feedback might have operated across glacial-interglacial cycles in the Cariaco Basin.

In both proposed feedback mechanisms, the dominant controlling factor is the surface ocean NO_3^- to PO_4^{3-} ratio (see Fig. 1.16). Both feedbacks are expected to operate in situations of excess NO_3^- (i.e., high NO_3^- to PO_4^{3-} ratio, shown at the bottom of the feedback loop in Fig. 1.16), as well as in situations of NO_3^- deficiency (i.e., low NO_3^- to PO_4^{3-} ratio, shown at the top of the feedback loop). If this view is correct, these two feedbacks would provide a rather tight control of the marine nitrogen cycle, creating a well balanced homeostasis. A further consequence is that

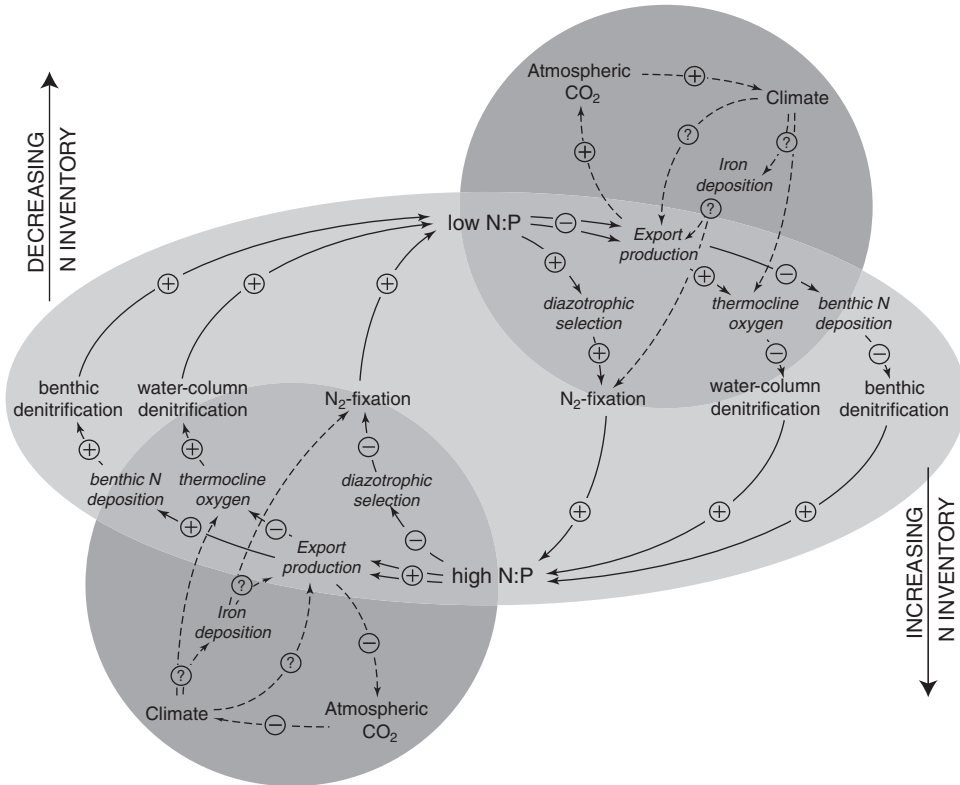

Figure 1.16 Schematic representation of feedbacks within the marine nitrogen cycle. The inner light grey ellipse shows the two nitrogen cycle “internal” feedback loops that tend to be stabilizing. These two feedback are proposed to be mainly controlled by the NO_3^- to PO_4^{3-} (N:P) ratio in surface waters. If the surface N:P ratio is low, denitrification tends to get reduced because of lower surface productivity, while N_2 fixation tends to increase because of favorable conditions for diazotrophic organisms. Both processes lead to an increase in the oceanic fixed nitrogen inventory. In contrast, when the surface N:P ratio is high, N_2 fixation tends to decrease, while denitrification increases, leading to a reduction of the oceanic fixed nitrogen inventory. These nitrogen internal feedbacks can be altered significantly by their interaction with the carbon cycle, climate and other processes (dark grey ellipses). The sign of these feedbacks are currently not understood and can be either positive or negative, leading to stabilizing or destabilizing feedbacks. From Gruber (2004).

on time-scales longer than the residence time of phosphorus in the ocean (i.e., about 30,000 to 50,000 years (Delaney, 1998)), the marine nitrogen cycle would be completely slaved to the marine phosphorus cycle, making PO_4^{3-} the ultimate limiting nutrient (Tyrrell, 1999). This view can be traced back to Redfield (1958) and is shared by many geochemists (e.g., Broecker and Peng (1982), see discussion by Codispoti (1989)). This also would move processes that control the marine phosphorus content, such as erosion on land, and burial in marine sediments to the center of attention if one wants to understand past oceanic productivity (Lenton

and Watson, 2000). However, upon closer inspection, the processes and factors controlling marine N_2 fixation and denitrification are more complex than simply the NO_3^- to PO_4^{3-} ratio of surface waters.

A first challenge to the PO_4^{3-} control hypothesis emerges from the observation that the tropical and subtropical North Atlantic are sites of high N_2 fixation (Capone *et al.*, 2005; Carpenter and Romans, 1991), yet these waters have extremely low PO_4^{3-} concentrations (Wu *et al.*, 2000). By contrast, there appear to be vast regions in the South Pacific that have substantial residual PO_4^{3-} concentrations, yet there is little evidence for enhanced N_2 fixation (Carpenter, 1983). Clearly, other factors besides the NO_3^- to PO_4^{3-} ratio must play a role in controlling N_2 fixation. Karl *et al.* (2002) suggested temperature, light, and the ambient concentrations of O_2 , NO_3^- , NH_4^+ , and essential trace metals. In particular, the availability of iron has been proposed as a major factor controlling N_2 fixation, based on the argument that N_2 fixers have a particularly high iron demand (Falkowski, 1997). If this was correct, there would exist substantial potential for the marine nitrogen cycle to escape the proposed negative feedbacks, and cause major changes in marine productivity and atmospheric CO_2 (Broecker and Henderson, 1998; Falkowski, 1997; Lenton and Watson, 2000; Michaels *et al.*, 2001).

The observed pattern of N_2 fixation, the distribution of N^* and the fact that the North Atlantic and to some degree the North Pacific receive much more iron from the atmosphere than the South Pacific appear to be consistent with the posit of iron playing an important role for controlling N_2 fixation. However, the evidence for large-scale iron limitation of N_2 fixation is largely circumstantial. Results from iron addition experiments are inconclusive (Hood *et al.*, 2000), or show that the stimulation is small unless PO_4^{3-} is added as well (Mills *et al.*, 2004). Recent analyses of the iron content in natural populations of *Trichodesmium* in the central Atlantic reveal neither a significantly higher iron requirement, nor a geographical pattern in cellular iron content consistent with patterns of iron deposition (Sanudo-Wilhelmy *et al.*, 2001). Rather, these authors assign PO_4^{3-} a key role in explaining the observed variability. More recently, Deutsch *et al.* (2007) pointed out that the global distribution of upper ocean NO_3^- and PO_4^{3-} , when interpreted diagnostically with a simple coupled ecological/physical model, suggest that N_2 fixation is mainly located in the Pacific Ocean and tends to be associated with regions of NO_3^- deficiency, i.e., PO_4^{3-} excess. They interpret these results as an indication that the NO_3^- to PO_4^{3-} ratio re-emerges as the primary factor controlling marine N_2 fixation, lending support to the N_2 -fixation-based negative feedback loop in Fig. 1.16.

What about the denitrification-based feedback loops? The primary factor controlling benthic denitrification is thought to be the supply of organic nitrogen to the sediments (Middelburg *et al.*, 1996). As the flux of organic nitrogen to the seafloor is primarily a function of surface export production and bottom depth, these two factors ultimately control benthic denitrification. The former is connected to the surface ocean NO_3^- content, providing support for the negative feedback loop. However, bottom topography can be changed independently, leading to the potential for decoupling benthic denitrification from N_2 fixation. Such a scenario was proposed by McElroy (1983), who suggested that the lowering of sea-level during the last glaciation caused a substantial decrease of benthic denitrification, leading to a higher marine fixed nitrogen inventory, and ultimately lower atmospheric CO_2 .

The primary factor controlling water column denitrification is the oxygen concentration. In the interior of the ocean, the condition for the generation of an oxygen depletion zone is given when the supply of O_2 by ocean transport from the surface ocean is smaller than the oxygen demand from the remineralization of organic matter. Therefore both low ventilation of the water column or high rates of remineralization of organic matter can cause oxygen depleted waters and hence water column denitrification. It appears that both processes are important for generating the oxygen depleted conditions in the three regions, where we currently observe such conditions i.e., the ETSP, the ETNP and the Arabian Sea. Therefore, the dependence of water column denitrification on surface ocean productivity and export provides the needed link for creating the proposed negative feedback loop. In contrast, the possibility of altering water column denitrification by changes in ocean circulation provides a potential avenue for undoing the tight control of the marine nitrogen content by the denitrification feedback loop. There is ample evidence in the geological record that water column denitrification indeed varied greatly in the past (Altabet *et al.*, 1995, 2002; Ganeshram *et al.*, 1995, 2000). However, evidence for large changes in glacial productivity are scarce, and in summary suggesting a rather similar biological productivity during those times, but with a different spatial distribution (Kohfeld *et al.*, 2005).

Despite substantial uncertainty, the view that emerges is an oceanic nitrogen cycle that is relatively well stabilized by the two proposed negative feedback loops. Both feedbacks operate on the time-scale of whole ocean overturning, i.e., decades to a few hundred years, thus keeping the system only in an approximate dynamic homeostasis, as on time-scales shorter than this, imbalances between N_2 fixation and denitrification can exist and significantly alter the fixed nitrogen content of the ocean. The internal feedbacks can be perturbed by outside factors, including changes in climate, iron deposition, and sea-level, some of which can form closed feedback loops (Fig. 1.16, see also Michaels *et al.* (2001)). While the basic structure of these controls on the marine nitrogen cycle seem relatively well established, there remain many open questions. For example, what is the role of iron limitation for marine N_2 fixation? For example, Lenton and Watson (2000) demonstrated on the basis of model simulations that the proposed negative feedback loops keep the marine nitrogen cycle indeed closely slaved to the marine phosphorus cycle under iron replete conditions. However, when they reduced the iron availability, N_2 fixation became decoupled from denitrification, leading to a substantial deficit in the marine nitrogen content relative to that of phosphorus.

5.2. The marine nitrogen cycle, carbon cycle, and climate

Given the importance of the marine nitrogen cycle in controlling marine productivity and the close connection between the marine carbon and nitrogen cycles (see Fig. 1.1), it is not surprising that changes in the marine nitrogen cycle were suggested very early on as a possible explanation of past variations in the global carbon cycle and particularly atmospheric CO_2 (e.g., McElroy (1983), and more recently Altabet *et al.* (1995), Ganeshram *et al.* (1995), Falkowski (1997), Broecker and Henderson (1998), and Michaels *et al.* (2001)) (see Chapter 34 by Galbraith *et al.* and Chapter 35

by Berman-Frank *et al.* for more in depth discussions). Although they vary in their details, the basic premise of all hypotheses is that it is possible to decouple marine N_2 fixation and denitrification enough to cause a long-term change in the marine inventory of fixed nitrogen. This change would then alter marine productivity, and consequently the ocean-atmosphere partition of CO_2 . However, as discussed above, it appears to be relatively difficult to keep the marine nitrogen cycle out of balance for a long time, as the negative feedbacks seem rather strong. This prevents sizeable variations in marine productivity to occur in response to alterations in the marine nitrogen cycle, limiting the strength of the nitrogen cycle-based hypotheses to explain past changes in atmospheric CO_2 .

A second argument against marine nitrogen cycle-based hypotheses is the observation that low- and mid-latitude alterations of the surface ocean CO_2 chemistry are generally much less efficient in changing atmospheric CO_2 than high-latitude changes (Broecker and Peng, 1998; Broecker *et al.*, 1999). This is primarily a result of the high-latitudes providing the “window” to the deep ocean, where most of the combined atmosphere-ocean carbon inventory resides. Since biological productivity in the high-latitudes, and particularly in the Southern Ocean are controlled by factors other than fixed nitrogen, the nitrogen-cycle based hypotheses primarily operate through changes in low- and mid-latitude productivity. This gives these hypotheses much less leverage on atmospheric CO_2 than iron based hypotheses that permit large changes in high-latitude productivity. In summary, despite a possibility for surprises given our limited understanding of the processes that lowered atmospheric CO_2 during the ice-ages, it appears as if changes in the marine nitrogen cycle have had relatively little influence on atmospheric CO_2 (Gruber, 2004).

Nevertheless, past changes in the marine nitrogen cycle were likely quite substantial. This is evidenced, for example, by the considerable changes in atmospheric N_2O associated with the glacial/interglacial transitions (Flückiger *et al.*, 1999), and the large changes in the extent of denitrification (Altabet *et al.*, 1995; Ganeshram *et al.*, 1995) and their possible connection with atmospheric CO_2 variations (Altabet *et al.*, 2002). However, our quantitative understanding of the past changes in the marine nitrogen cycle is only poorly developed, representing another major challenge of the marine nitrogen cycle. The development of a better quantitative understanding of these past changes is particularly important if we want to have some confidence in projecting the impact of future climate changes on the oceanic nitrogen cycle.

5.3. The anthropogenic perturbation

The direct anthropogenic perturbation of the global nitrogen cycle has been massive, leading to an enormous acceleration of this cycle (see Fig. 1.15 and Galloway *et al.* (1995), Vitousek *et al.* (1997), Galloway *et al.* (2002), and Gruber and Galloway (2008)). Although the widespread application of nitrogen-based fertilizers has been an important contributor to the ability of humans to grow enough despite a rapidly growing population, the negative environmental effects of this fertilizer use are widespread (Galloway *et al.*, 2002). In addition, the creation of reactive forms of nitrogen (mostly NO_x) during the combustion of fossil fuels has also increased dramatically over the last few decades, leading to problems as diverse as enhanced

tropospheric ozone formation, acid rain, and eutrophication in aquatic ecosystems. Galloway and Cowling (2002) introduced the term *nitrogen cascade* to emphasize that a fixed nitrogen molecule introduced into the environment by humans often leads to a whole series of impacts, some of which occur much later and far away from where the molecule was introduced first. For example, the application of nitrogen fertilizer on some agricultural patch may first lead to the loss of biodiversity. As some of this fertilizer gets washed into nearby streams, it leads to eutrophication there, and later, perhaps, in a lake downstream. If this fixed nitrogen escapes denitrification, it may end up in the coastal ocean, causing another episode of eutrophication.

On the global scale, there is little evidence so far that the acceleration of the global nitrogen cycle by humans has led to detectable changes in the marine nitrogen cycle (Duce *et al.*, 2008). This is not the case in many coastal regions, however, as there exist several well documented examples of coastal eutrophication in direct response to the input of anthropogenically derived nitrogen, mainly by rivers (see e.g., Beman *et al.* (2005), Rabalais (2002), and Chapter 11 by Paerl and Piehler, this volume for a discussion). The impact of these changes can be multi-faceted, ranging from the loss of habitat for fish due to reduced oxygen concentrations to the increased occurrence of blooms of harmful algae. Global creation of fixed nitrogen by humans is expected to increase severalfold in the next 100 years, perhaps going as high as 900 Tg N year⁻¹ (Galloway *et al.*, 2002). We therefore have to expect a substantial worsening of the coastal eutrophication problem, as well as to consider the possibility of sizeable direct changes in the nitrogen cycle of the open ocean.

In addition, humans will affect the nitrogen cycle likely also indirectly through anthropogenically induced climate change. Climate projections for the 21st century are inherently uncertain due to uncertainties in the nature and magnitude of future energy use as well as uncertainties in the global carbon cycle and the physical climate system, but it is likely that Earth will warm another few degrees Celsius in this century (see Houghton *et al.* (2001)). This could cause a number of feedbacks within the Earth system involving the marine nitrogen cycle (see Chapter 35 by Berman-Frank *et al.* and Gruber and Galloway (2008)).

For example, nearly all climate projections for the 21st century suggest that oceanic stratification will increase (Sarmiento *et al.*, 1998), primarily as a result of the input of heat into the surface ocean, but in part also by a freshening of the upper ocean. This will likely cause a decrease in export production in the low latitudes, as it will restrict the upward transport of nutrients (Bopp *et al.*, 2001; Matear and Hirst, 1999; Sarmiento *et al.*, 1998;). On the other hand, export production in the mid-to-high-latitudes may actually increase due to lower light stress in a shallower mixed layer (Bopp *et al.*, 2001).

The details of these productivity changes vary from model to model, but the future warming acting in concert with increased stratification and reduced ventilation of the thermocline will almost certainly decrease the oxygen content of the ocean's interior (Bopp *et al.*, 2002; Deutsch *et al.*, 2005; Matear *et al.*, 2000; Plattner *et al.*, 2002). This would enhance denitrification and the production of nitrous oxide. Unless this increased loss of nitrogen is compensated by increased N₂ fixation, the resulting decrease in the inventory of fixed nitrogen and biological productivity

would result in a net loss of CO₂ from the ocean, causing a positive feedback. The increased production of nitrous oxide would constitute a second positive feedback, leading to an overall acceleration of climate change due to the interaction of the climate system with the marine nitrogen cycle.

6. CONCLUSIONS

Although the marine nitrogen cycle occupies a central role within the biogeochemical cycles of the sea, we have just barely begun to understand its major processes and the factors that regulate them. This occurs at a time when human interventions in the Earth system has risen to unprecedented levels, with a particularly strong impact on the global nitrogen cycle. Although the nitrogen cycle in the open ocean appears to have remained largely unscathed from human influence, many coastal systems have already been seriously impacted. Projections of the future suggest that this may change soon, either directly by the continued addition of anthropogenically created fixed nitrogen to the Earth system and its cascading effects, or indirectly through anthropogenically induced climate change. Some of these alterations have the potential to cause positive feedbacks in the climate system, but they are neither well understood nor quantified. It behooves us well to address these difficult, but exciting challenges.

ACKNOWLEDGEMENTS

This work was supported by the U.S. National Science Foundation (EAR-0404405) and the Office of Science (BER), U.S. Department of Energy, Grant No. DE-FG03-00ER63010. I thank Raleigh R. Hood and an anonymous reviewer for their helpful comments.

REFERENCES

- Altabet, M. A., Francois, R., Murray, D. W., and Prell, W. L. (1995). Climate-related variations in denitrification in the Arabian Sea from sediment ¹⁵N/¹⁴N ratios. *Nature* **373**, 506–509.
- Altabet, M. A., Higginson, M. J., and Murray, D. W. (2002). The effect of millennial-scale changes in Arabian Sea denitrification on atmospheric CO₂. *Nature* **415**, 159–162.
- Anderson, L. A. (1995). On the hydrogen and oxygen content of marine phytoplankton. *Deep Sea Res. I* **42**(9), 1675–1680.
- Anderson, L. A., and Sarmiento, J. L. (1994). Redfield ratios of remineralization determined by nutrient data analysis. *Global Biogeochem. Cycles* **8**(1), 65–80.
- Aufdenkampe, A. K., McCarthy, J. J., Rodier, M., Navarrette, C., Dunne, J., and Murray, J. W. (2001). Estimation of new production in the tropical Pacific. *Global Biogeochem. Cycles* **15**, 101–112.
- Beman, J. M., Arrigo, K. R., and Matson, P. A. (2005). Agricultural runoff fuels large phytoplankton blooms in vulnerable areas of the ocean. *Nature* **434**, 211–214.
- Bopp, L., Monfray, P., Aumont, O., Dufresne, J. L., Treut, H. L., Madec, G., Terray, L., and Orr, J. C. (2001). Potential impact of climate change on marine export production. *Global Biogeochem. Cycles* **15**(1), 81–99.

- Bopp, L., LeQuéré, C., Heimann, M., Manning, A., and Monfray, P. (2002). Climate-induced oceanic oxygen fluxes: Implications for the contemporary carbon budget. *Global Biogeochem. Cycles* **16**(2), 1022, doi:10.1029/2001GB001445.
- Boyd, P. W., Watson, A. J., Law, C. S., Abraham, E. R., Trull, T., Murdoch, R., Bakker, D. C. E., Bowie, A. R., Buesseler, K. O., Chang, H., Charette, M., Croot, P., *et al.* (2000). A mesoscale phytoplankton bloom in the polar Southern Ocean stimulated by iron fertilization. *Nature* **407**, 695–702.
- Boyd, P. W., Law, C., Wong, C., Nojiri, Y., Tsuda, A., Levasseur, M., Takeda, S., Rivkin, R., Harrison, P., Strzeppek, R., Gower, J., McKay, R., *et al.* (2004). The decline and fate of an iron-induced subarctic phytoplankton bloom. *Nature* **428**, 549–553.
- Brandes, J. A., and Devol, A. H. (2002). A global marine-fixed nitrogen isotopic budget: Implications for Holocene nitrogen cycling. *Global Biogeochem. Cycles* **16**(4), doi:10.1029/2001GB001856.
- Brandes, J. A., Devol, A. H., and Deutsch, C. A. (2007). New developments in the marine nitrogen cycle. *Chem. Rev.* **107**, 577–589.
- Brix, H., Gruber, N., Karl, D. M., and Bates, N. R. (2006). On the relationships between primary, net community, and export production in subtropical gyres. *Deep Sea Res. II* **53**(5–7), 698–717, doi:10.1016/j.dsr2.2006.01.024.
- Broecker, W. (1991). The great ocean conveyor. *Oceanography* **4**(2), 79–89.
- Broecker, W. S., and Henderson, G. M. (1998). The sequence of events surrounding Termination II and their implications for the cause of glacial-interglacial CO₂ changes. *Paleoceanogr.* **13**(4), 352–364.
- Broecker, W. S., and Peng, T. H. (1982). “Tracers in the Sea.” Eldigio Press, Lamont-Doherty Geological Observatory, Palisades, NY.
- Broecker, W. S., and Peng, T. H. (1998). “Greenhouse Puzzles,” 2nd edition. Eldigio Press, Lamont Doherty Earth Observatory of Columbia University, Palisades, NY.
- Broecker, W. S., Lynch-Stieglitz, J., Archer, D., Hofmann, M., Maier-Reimer, E., Marchal, O., Stocker, T. F., and Gruber, N. (1999). How strong is the Harvardton-Bear constraint? *Global Biogeochem. Cycles* **13**(4), 817–820.
- Bronk, D. A. (2002). Dynamics of DON. “Biogeochemistry of Marine Dissolved Organic Matter” (Hansell, D. A. and Carlson, C. A., eds.). Academic Press, San Diego. Chapter 5, pp. 153–247.
- Bronk, D. A., Gilbert, P. M., and Ward, B. B. (1994). Nitrogen uptake, dissolved nitrogen release, and new production. *Science* **265**, 1843–1856.
- Brzezinski, M. A. (1988). Vertical distribution of ammonium in stratified oligotrophic waters. *Limnol. Oceanogr.* **33**(5), 1176–1182.
- Brzezinski, M. A., Sarmiento, J. L., Matsumoto, K., Pride, C. J., Sigman, D. M., Gruber, N., Rau, G. H., and Coale, K. H. (2002). A switch from Si(OH)₄ to NO₃⁻ depletion in the glacial Southern Ocean. *Geophys. Res. Lett.* **29**(12), 5.1–5.4, doi: 10.1029/2001GL014349.
- Buesseler, K. O., Antia, A. N., Chen, M., Fowler, S. W., Gardner, W. D., Gustafson, Ö., Harada, K., Michaels, A. F., Rutgers van der Loeff, M., Sarin, M., Steinberg, D. K., and Trull, T. (2007). An assessment of the use of sediment traps for estimating upper ocean particle fluxes. *J. Mar. Res.* **65**(3), 345–416.
- Capone, D. G. (1983). Benthic nitrogen fixation. “Nitrogen in the Marine Environment” (Carpenter, E. J. and Capone, D. G., eds.). Academic Press, San Diego, CA. pp. 105–137.
- Capone, D. G. (2001). Marine nitrogen fixation: what’s the fuss? *Curr. Opin. Microbiol.* **4**, 341–348.
- Capone, D. G., Zehr, J. P., Paerl, H. W., Bergman, B., and Carpenter, E. J. (1997). *Trichodesmium*, a globally significant marine cyanobacterium. *Science* **276**, 1221–1229.
- Capone, D. G., Burns, J. A., Montoya, J. P., Subramaniam, A., Mahaffey, C., Gunderson, T., Michaels, A. F., and Carpenter, E. J. (2005). Nitrogen fixation by *trichodesmium* spp.: An important source of new nitrogen to the tropical and subtropical North Atlantic Ocean. *Global Biogeochem. Cycles* **19**, GB2024, doi:10.1029/2004GB002331.
- Carpenter, E. J. (1983). Nitrogen fixation by marine Oscillatoria (*trichodesmium*) in the world’s oceans. In “Nitrogen in the Marine Environment” (Carpenter, E. J. and Capone, D. G., eds.). Academic Press, San Diego, CA. pp. 65–103.
- Carpenter, E. J., and Romans, K. (1991). Major role of the cyanobacterium *trichodesmium* in nutrient cycling in the North Atlantic Ocean. *Science* **254**, 1356–1358.

- Carpenter, E. J., Montoya, J. P., Burns, J., Mulholland, M. R., Subramaniam, A., and Capone, D. G. (1999). Extensive bloom of a N₂-fixing diatom/cyanobacterial association in the tropical Atlantic Ocean. *Mar. Ecol. Progr. Ser.* **185**, 273–283.
- Castro, C. G., Chavez, F. P., and Collins, C. A. (2001). Role of the California undercurrent in the export of denitrified waters from the eastern tropical North Pacific. *Global Biogeochem. Cycles* **15**(4), 819–830.
- Christensen, J. P., Murray, J. W., Devol, A. H., and Codispoti, L. A. (1987). Denitrification in continental shelf sediments has major impact on the oceanic nitrogen budget. *Global Biogeochem. Cycles* **1**(2), 97–116.
- Clark, D. R., Fileman, T. W., and Joint, I. (2006). Determination of ammonium regeneration rates in the oligotrophic ocean by gas chromatography/mass spectrometry. *Mar. Chem.* **98**, 121–130.
- Coale, K. H., Johnson, K. S., Fitzwater, S. E., Gordon, R. M., Tanner, S., Chavez, F. P., Ferioli, L., Sakamoto, C., Rogers, P., Millero, F., Steinberg, P., Nightingale, P., et al. (1996). A massive phytoplankton bloom induced by an ecosystem-scale iron fertilization experiment in the equatorial Pacific ocean. *Nature* **383**, 495–501.
- Coale, K. H., Johnson, K. S., Chavez, F. P., Buesseler, K. O., Barber, R. T., Brzezinski, M. A., Cochlan, W. P., Millero, F. J., Falkowski, P. G., Bauer, J. E., Wanninkhof, R. H., Kudela, R. M., et al. (2004). Southern Ocean iron enrichment experiment: Carbon cycling in high- and low-Si waters. *Science* **304**, 408–414.
- Codispoti, L. A. (1983). Nitrogen in upwelling systems. In “Nitrogen in the Marine Environment” (Carpenter, E. J. and Capone, D. G., eds.). Academic Press, San Diego, CA. Chapter 5, pp. 513–564.
- Codispoti, L. A. (1989). Phosphorus vs. nitrogen limitation of new and export production. In “Productivity of the Ocean: Present and Past” (Berger, W. H., Smetacek, V. S., and Wefer, G., eds.). Wiley, New York. pp. 377–394.
- Codispoti, L. A. (2006). An oceanic fixed nitrogen sink exceeding 400 Tg N a⁻¹ vs the concept of homeostasis in the fixed-nitrogen inventory. *Biogeosciences* **3**, 1203–1246.
- Codispoti, L. A., and Christensen, J. P. (1985). Nitrification, denitrification and nitrous oxide cycling in the Eastern Tropical South Pacific Ocean. *Mar. Chem.* **16**, 277–300.
- Codispoti, L. A., and Packard, T. T. (1980). Denitrification rates in the eastern tropical South Pacific. *J. Mar. Res.* **38**(3), 453–477.
- Codispoti, L. A., and Richards, F. A. (1976). An analysis of the horizontal regime of denitrification in the eastern tropical North Pacific. *Limnol. Oceanogr.* **21**(3), 379–388.
- Codispoti, L. A., Friederich, G. E., Packard, T. T., Glover, H. E., Kelly, P. J., Spinrad, R. W., Barber, R. T., Elkins, J. W., Ward, B. B., Lipschultz, F., and Lostaunau, N. (1986). High nitrite levels off Northern Peru: A signal of instability in the marine denitrification rate. *Science* **233**, 1200–1202.
- Codispoti, L. A., Brandes, J. A., Christensen, J. P., Devol, A. H., Naqvi, S. W. A., Paerl, H. W., and Yoshinari, T. (2001). The oceanic fixed nitrogen and nitrous oxide budgets: Moving targets as we enter the anthropocene? *Sci. Mar.* **65**(Suppl. 2), 85–105.
- Conkright, M. E., Locarnini, R. A., Garcia, H., Brien, T. O., Boyer, T., Stephens, C., and Antonov, J. (2002). World Ocean Atlas 2001: Objective analyses, data statistics, and figures, CD-ROM documentation, NODC Tech. Report. National Oceanographic Data Center. Silver Spring, MD.
- Cullen, J. J. (1991). Hypotheses to explain high-nutrient, low-chlorophyll conditions in the open sea. *Limnol. Oceanogr.* **36**, 1587–1599.
- Dalsgaard, T., Canfield, D. E., Petersen, J., Thamdrup, B., and Gonzalez, J. A. (2003). N₂ production by the anammox reaction in the anoxic water column of Golfo Dulce, Costa Rica. *Nature* **422**, 606–608.
- Davis, C. C., and McGillicuddy, D. J. (2006). Transatlantic abundance of the N₂ fixing colonial cyanobacterium *Trichodesmium*. *Science* **312**, 1517–1520.
- Delaney, M. L. (1998). Phosphorus accumulation in marine sediments and the oceanic phosphorus cycle. *Global Biogeochem. Cycles* **12**(4), 563–572.
- Deutsch, C., Sigman, D. M., Thunell, R. C., Meckler, A. N., and Haug, G. H. (2004). Isotopic constraints on glacial/interglacial changes in the oceanic nitrogen budget. *Global Biogeochem. Cycles* **18**, GB4012, doi:10.1029/2003GB002189.
- Deutsch, C., Emerson, S., and Thompson, L. (2005). Fingerprints of climate change in North Pacific oxygen. *Geophys. Res. Lett.* **32**(16), L16604, doi:10.1029/2005GL023190.

- Deutsch, C., Sarmiento, J. L., Sigman, D. M., Gruber, N., and Dunne, J. P. (2007). Spatial coupling of nitrogen inputs and losses in the ocean. *Nature* **445**, 163–167.
- Devol, A. H., and Christensen, J. P. (1993). Benthic fluxes and nitrogen cycling in sediments of the continental margin of the eastern North Pacific. *J. Mar. Res.* **51**(2), 345–372.
- Dore, J. E., and Karl, D. M. (1996). Nitrite distributions and dynamics at Station ALOHA. *Deep Sea Res. II* **43**(2–3), 385–402.
- Duce, R. (1986). The impact of atmospheric nitrogen, phosphorus and iron species on marine biological productivity. In “The Role of Air–Sea Exchange in Geochemical Cycling” (Buat-Ménard, P., ed.). D. Reidel Publishing Company, Hingham, MA. pp. 497–529.
- Duce, R. A. *et al.* (2008) Impacts of atmospheric anthropogenic nitrogen on the open ocean. *Sciences* **320**, 893–897.
- Ducklow, H. W. (1995). Ocean biogeochemical fluxes: New production and export of organic matter from the upper ocean. *Rev. Geophys., Suppl.* 1271–1276.
- Ducklow, H. W., Steinberg, D. K., and Buesseler, K. O. (2001). Upper ocean carbon export and the biological pump. *Oceanography* **14**(4), 50–58.
- Dugdale, R. C., and Goering, J. J. (1967). Uptake of new and regenerated forms of nitrogen in primary productivity. *Limnol. Oceanogr.* **12**, 196–206.
- Eppley, R. W., and Peterson, B. J. (1979). Particulate organic matter flux and planctonic new production in the deep ocean. *Nature* **282**, 677–680.
- Falkowski, P. G. (1997). Evolution of the nitrogen cycle and its influence on the biological sequestration of CO₂ in the ocean. *Nature* **387**, 272–275.
- Field, C. B., Behrenfeld, M. J., Randerson, J., and Falkowski, P. (1998). Primary productivity of the biosphere: an integration of terrestrial and oceanic components. *Science* **281**, 237–240.
- Flückiger, J., Dällenbach, A., Blunier, T., Stauffer, B., Stocker, T. F., Raynaud, D., and Barnola, J. M. (1999). Variations in atmospheric N₂O concentration during abrupt climate changes. *Science* **285**, 227–230.
- Falkowski, P. G., Scholes, R. J., Boyle, E., Canadell, J., Canfield, D., Elser, J., Gruber, N., Hibbard, K., Högberg, P., Linder, S., Mackenzie, F. T., Moore, B., III, *et al.* (2000). The global carbon cycle: A test of our knowledge of Earth as a system. *Science* **290**, 291–296.
- Falkowski, P. G., Laws, E. A., Barber, R. T., and Murray, J. W. (2003). Phytoplankton and their role in primary, new, and export production. In “Ocean Biogeochemistry” (Fasham, M. J. R. eds.). Springer, Berlin. Chapter 4, pp. 99–121.
- Follows, M. J., Ito, T., and Marotzke, J. (2002). The wind-driven, subtropical gyres and the solubility pump of CO₂. *Global Biogeochem. Cycles* **16**(4), 1113, doi:10.1029/2001GB001786.
- Galloway, J. N. (1998). The global nitrogen cycle: changes and consequences. *Environ. Pollut.* **102**(S1), 15–24.
- Galloway, J. N., and Cowling, E. B. (2002). Reactive nitrogen and the world: 200 years of change. *Ambio* **31**(2), 64–71.
- Galloway, J. N., Schlesinger, W. H., Levy, H., II, Michaels, A., and Schnoor, J. L. (1995). Nitrogen fixation: Anthropogenic enhancement–environmental response. *Global Biogeochem. Cycles* **9**(2), 235–252.
- Galloway, J. N., Cowling, E. B., Seitzinger, S. P., and Socolow, R. H. (2002). Reactive nitrogen: Too much of a good thing? *Ambio* **31**(2), 60–64.
- Galloway, J. N., Dentener, F. J., Capone, D. G., Boyer, E. W., Howarth, R. W., Seitzinger, S. P., Asner, G. P., Cleveland, C. C., Green, P. A., Holland, E. A., Karl, D. M., Michaels, A. F., Porter, J. H., *et al.* (2004). Nitrogen cycles: past, present, future. *Biogeochemistry* **70**, 153–226.
- Ganeshram, R. S., Pedersen, T. F., Calvert, S. E., and Murray, J. W. (1995). Large changes in oceanic nutrient inventories from glacial to interglacial periods. *Nature* **376**, 755–758.
- Ganeshram, R. S., Pedersen, T. F., Calvert, S. E., McNeil, G. W., and Fontugne, M. R. (2000). Glacial-interglacial variability in denitrification in the world’s ocean: Causes and consequences. *Paleoceanogr.* **15**(4), 301–376.
- Granger, J., and Ward, B. B. (2003). Accumulation of nitrogen oxides in copper-limited cultures of denitrifying bacteria. *Limnol. Oceanogr.* **48**, 313–318.
- Gruber, N. (2004). The dynamics of the marine nitrogen cycle and atmospheric CO₂. In “Carbon Climate interactions” (Oguz, T., and Follows, M., eds.). Kluwer, Dordrecht. pp. 97–148.

- Gruber, N. (2005). A bigger nitrogen fix. *Nature* **436**, 786–787.
- Gruber, N., and Galloway, J. N. (2008). An earth-system perspective of the global nitrogen cycle. *Nature* **451**, 293–296.
- Gruber, N., and Sarmiento, J. L. (1997). Global patterns of marine nitrogen fixation and denitrification. *Global Biogeochem. Cycles* **11**(2), 235–266.
- Gruber, N., and Sarmiento, J. L. (2002). Large-scale biogeochemical/physical interactions in elemental cycles. In “THE SEA: Biological–Physical Interactions in the Oceans” (Robinson, A. R., McCarthy, J. J., and Rothschild, B. J. eds.), Vol. 12, Wiley, New York. pp. 337–399.
- Gruber, N., Friedlingstein, P., Field, C. B., Valentini, R., Heimann, M., Richey, J. E., Romero-Lankao, P., Schulze, D., and Chen, C. (2004). The vulnerability of the carbon cycle in the 21st century: An assessment of carbon-climate-human interactions. In “The Global Carbon Cycle: Integrating Humans, Climate, and the Natural World” (Field, C. B. and Raupach, M. R. eds.). Island Press, Washington, D.C. Chapter 2, pp. 45–76.
- Hanawa, K., and Talley, L. D. (2001). Mode waters. In “Ocean Circulation and Climate” (Siedler, G. and Church, J., eds.). Academic Press, San Diego, CA. pp. 373–386.
- Hansell, D. A., Bates, N. R., and Olson, D. B. (2004). Excess nitrate and nitrogen fixation in the Subtropical North Atlantic. *Mar. Chem.* **84**, 243–265.
- Hattori, A. (1983). Denitrification and dissimilatory nitrate reduction. In “Nitrogen in the Marine Environment” (Carpenter, E. J. and Capone, D. G. eds.). Academic Press, San Diego, CA, pp. 191–232.
- Haug, G. H., Pedersen, T. F., Sigman, D., Calvert, S., and Nielsen, B. (1998). Glacial/interglacial variations in productivity and nitrogen fixation in the Cariaco basin during the last 550 ka. *Paleoceanogr.* **13**(5), 427–432.
- Hebel, D. V., and Karl, D. M. (2001). Seasonal, interannual and decadal variations in particulate matter concentrations and composition in the subtropical North Pacific Ocean. *Deep Sea Res. II* **48**(8), 1669–1695.
- Hedges, J. I., Baldock, J., Gelin, Y., Lee, C., Peterson, M., and Wakeham, S. (2002). The biochemical and elemental compositions of marine plankton: A NMR perspective. *Mar. Chem.* **78**(1), 47–63.
- Herbland, A., and Voituriez, B. (1979). Hydrological structure analysis for estimating primary production in the tropical Atlantic Ocean. *J. Mar. Res.* **37**, 87–101.
- Hood, R. H., Michaels, A. F., and Capone, D. G. (2000). The enigma of marine nitrogen fixation: answers on the horizon. *Eos Trans. AGU* **81**(13), 133–139.
- Houghton, J. T., Ding, Y., Griggs, D. J., Noguer, M., van der Linden, P., Dai, X., Maskell, K., and Johnson, C. A. (2001). “Climate Change 2001: The Scientific Basis.” Cambridge University Press, New York.
- Ito, T., Follows, M. J., and Boyle, E. A. (2004). Is AOU a good measure of respiration in the oceans? *Geophys. Res. Lett.* **31**, L17305, doi:10.1029/2004GL020900.
- Jin, X., and Gruber, N. (2003). Offsetting the radiative benefit of ocean iron fertilization by enhancing N₂O emission. *Geophys. Res. Lett.* **30**(24), 2249, doi:10.1029/2003GL018458.
- Jones, R. D. (1991). An improved fluorescence method for the determination of nanomolar concentrations of Ammonium in natural waters. *Limnol. Oceanogr.* **36**(4), 814–819.
- Karl, D., Letelier, R., Tupas, L., Dore, J., Christian, J., and Hebel, D. (1997). The role of nitrogen fixation in the biogeochemical cycling in the subtropical North Pacific Ocean. *Nature* **388**, 533–538.
- Karl, D. M., Michaels, A. F., Bergman, B., Capone, D., Carpenter, E., Letelier, R., Lipschultz, F., Paerl, H., Sigman, D., and Stal, L. (2002). Dinitrogen fixation in the world’s ocean. *Biogeochemistry* **57/58**, 47–98.
- Klausmeier, C. A., Litchman, E., Daufresne, T., and Levin, S. A. (2004). Optimal nitrogen-to-phosphorus stoichiometry of phytoplankton. *Nature* **429**, 171–174.
- Kohfeld, K. E., Quéré, C. L., Harrison, S. P., and Anderson, R. F. (2005). Role of marine biology in glacial-interglacial CO₂ cycles. *Science* **308**, 74–78.
- Kuypers, M. M. M., Sliemers, A. O., Lavik, G., Schmid, M., Jorgensen, B. B., Kuenen, J. G., Damste, J. S. S., Strous, M., and Jetten, M. S. M. (2003). Anaerobic ammonium oxidation by anammox bacteria in the Black Sea. *Nature* **422**, 608–610.

- Kuypers, M. M. M., Lavik, G., Wobeken, D., Schmid, M., Fuchs, B. M., Amann, R., Jorgensen, B. B., and Jetten, M. S. M. (2005). Massive nitrogen loss from the Benguela upwelling system through anaerobic ammonium oxidation. *Proceedings of the National Academy of Sciences* **102** (18), 6478–6483.
- Laws, E. A. (1991). Photosynthetic quotients, new production and net community production in the open ocean. *Deep Sea Res.* **38**(1), 143–167.
- Laws, E. A., Falkowski, P., Carpenter, E., and Ducklow, H. (2000). Temperature effects on export production in the open ocean. *Global Biogeochem. Cycles* **14**(4), 1231–1246.
- Lenton, T. M., and Watson, A. J. (2000). Redfield revisited 1: Regulation of nitrate, phosphate, and oxygen in the ocean. *Global Biogeochem. Cycles* **14**(1), 225–248.
- Lipschultz, F., Zafriou, O. C., and Ball, L. A. (1996). Seasonal fluctuations of nitrite concentrations in the deep oligotrophic ocean. *Deep Sea Res. II* **43**(2–3), 403–419.
- Mahaffey, C., Capone, D., and Michaels, A. (2005). The conundrum of marine N₂ fixation. *Am. J. Sci.* **305**, 546–595.
- Mantoura, R. F. C., Law, C. S., Owens, N. J. P., Burkill, P. H., Woodward, E. M. S., Howland, R. J. M., and Lewellyn, C. A. (1993). Nitrogen biogeochemical cycling in the north-western Indian ocean. *Deep Sea Res. II* **40**(3), 651–671.
- Martin, J. H. (1990). Glacial-interglacial CO₂ change: the iron hypothesis. *Paleoceanogr.* **5**(1), 1–13.
- Martin, J. H., Knauer, G. A., Karl, D. M., and Broenkow, W. W. (1987). Vertex: carbon cycling in the northeast Pacific. *Deep Sea Res.* **34**(2), 267–285.
- Martin, J. H., Coale, K. H., Johnson, K. S., Fitzwater, S. E., Gordon, R. M., Tanner, S. J., Hunter, C. N., Elrod, V. A., Nowicki, J. L., Coley, T. L., Barber, R. T., Lindley, S., *et al.* (1994). Testing the iron hypothesis in ecosystems of the equatorial Pacific ocean. *Nature* **371**, 123–129.
- Matear, R. J., and Hirst, A. C. (1999). Climate change feedback on the future oceanic CO₂ uptake. *Tellus, Ser. B* **51**, 722–733.
- Matear, R. J., Hirst, A. C., and McNeil, B. I. (2000). Changes in dissolved oxygen in the Southern Ocean with climate change. *Geochem. Geophys. Geosyst.* **1**, 2000GC000086.
- McElroy, M. B. (1983). Marine biological controls on atmospheric CO₂ and climate. *Nature* **302**, 328–329.
- Michaels, A. F., Olson, D., Sarmiento, J. L., Ammerman, J., Fanning, K., Jahnke, R., Knap, A. H., Lipschultz, R., and Prospero, J. (1996). Inputs, losses and transformations of nitrogen and phosphorus in the pelagic North Atlantic Ocean. *Biogeochemistry* **35**, 181–226.
- Michaels, A. F., Karl, D. M., and Capone, D. G. (2001). Element stoichiometry, new production, and nitrogen fixation. *Oceanography* **14**(4), 68–77.
- Middelburg, J. J., Soetaert, K., Herman, P. M. J., and Heip, C. H. R. (1996). Denitrification in marine sediments: A model study. *Global Biogeochem. Cycles* **10**(4), 661–673.
- Mills, M. M., Ridame, M. D. C., LaRoche, J., and Geider, R. J. (2004). Iron and phosphorus co-limit nitrogen fixation in the eastern tropical North Atlantic. *Nature* **429**, 292–294.
- Moore, L. R., Post, A. F., Rocab, G., and Chisholm, S. W. (2002). Utilization of different nitrogen sources by the marine cyanobacteria *prochlorococcus* and *synechococcus*. *Limnol. Oceanogr.* **47**(4), 989–996.
- Morrison, J. M., Codispoti, L. A., Smith, S. L., Wishner, K., Flagg, C., Gardner, W. D., Gaurin, S., Naqvi, S. W. A., Manghnani, V., Prosperie, L., and Gundersen, J. S. (1999). The oxygen minimum zone in the Arabian Sea during 1995. *Deep Sea Res. II* **46**, 1903–1931.
- Naqvi, S. W. A. (1987). Some aspects of the oxygen-deficient conditions and denitrification in the Arabian Sea. *J. Mar. Res.* **45**, 1049–1072.
- Naqvi, S. W. A., Noronha, R. J., and Reddy, C. V. G. (1982). Denitrification in the Arabian Sea. *Deep Sea Res.* **29**(4A), 459–469.
- Neuer, S., Davenport, R., Freudenthal, T., Wefer, G., Llinás, O., Rueda, M. J., Steinberg, D. K., and Karl, D. M. (2002). Differences in the biological carbon pump at three subtropical ocean sites. *Geophys. Res. Lett.* **29**(18), 1885, doi:10.1029/2002GL015393.
- Nevison, C. D., Butler, J., and Elkins, J. (2003). Global distribution of N₂O and the δN₂O/AOU yield in the subsurface ocean. *Global Biogeochem. Cycles* **17**(4), 1119, doi:10.1029/2003GB002068.
- Plattner, G. K., Joos, F., and Stocker, T. F. (2002). Revision of the global carbon budget due to changing air-sea oxygen fluxes. *Global Biogeochem. Cycles* **16**(4), 1096, doi:10.1029/2001GB001746.

- Plattner, G. K., Gruber, N., Frenzel, H., and McWilliams, J. C. (2005). Decoupling marine export production from new production. *Geophys. Res. Lett.* **32**, L11612, doi:10.1029/2005GL022660.
- Prather, M., Ehhalt, D., Dentener, F., Derwent, R., Dlugokencky, E., Holland, E., Isaksen, I., Katima, J., Kirchhoff, V., Matson, P., Midgley, P., and Wang, M. (2001). Atmospheric chemistry and greenhouse gases. In "Climate Change 2001: The Scientific Basis. Contribution of Working Group I to the Third Assessment Report of the Intergovernmental Panel on Climate Change" (Houghton, J. T., Ding, Y., Griggs, D. J., Noguer, M., van der Linden, P., Dai, X., Maskell, K., and Johnson, C. A., eds.). Cambridge University Press, Cambridge, UK, Chapter 4. pp. 527–585.
- Rabalais, N. N. (2002). Nitrogen in aquatic environments. *Ambio* **31**(2), 102–112.
- Ramaswamy, V., Boucher, O., Haigh, J., Hauglustaine, D., Haywood, J., Myhre, G., Nakajima, T., Shi, G. Y., and Solomon, S. (2001). Radiative forcing of climate change. In "Climate Change 2001: The Scientific Basis. Contribution of Working Group I to the Third Assessment Report of the Intergovernmental Panel on Climate Change" (Houghton, J. T., Ding, Y., Griggs, D. J., Noguer, M., van der Linden, P., Dai, X., Maskell, K., and Johnson, C. A., eds.). Cambridge University Press, Cambridge, Chapter 6. pp. 527–585.
- Redfield, A. C. (1958). The biological control of chemical factors in the environment. *Am. Sci.* **46**, 205–221.
- Redfield, A. C., Ketchum, B. H., and Richards, F. A. (1963). The influence of organisms on the composition of sea-water. In "The Sea" (Hill, M. N., ed.). Vol. 2, Wiley-Interscience, New York. pp. 26–77.
- Sanudo-Wilhelmy, S. A., Kustka, A. B., Gobler, C. J., Hutchins, D. A., Yang, M., Lwiza, K., Burns, J., Capone, D. G., Raven, J. A., and Carpenter, E. J. (2001). Phosphorus limitation of nitrogen fixation by *trichodesmium* in the central Atlantic ocean. *Nature* **411**, 66–69.
- Sarmiento, J. L., and Gruber, N. (2006). "Ocean Biogeochemical Dynamics." Princeton University Press, Princeton, NJ.
- Sarmiento, J. L., and Orr, J. C. (1991). Three-dimensional simulations of the impact of Southern Ocean nutrient depletion on atmospheric CO₂ and ocean chemistry. *Limnol. Oceanogr.* **36**(8), 1928–1950.
- Sarmiento, J. L., and Toggweiler, J. R. (1984). A new model for the role of the oceans in determining atmospheric pCO₂. *Nature* **308**, 621–624.
- Sarmiento, J. L., Rooth, C. G. H., and Roether, W. (1982). The North Atlantic tritium distribution in 1972. *J. Geophys. Res.* **87**(C10), 8047–8056.
- Sarmiento, J. L., Hughes, T. M. C., Stouffer, R. J., and Manabe, S. (1998). Simulated response of the ocean carbon cycle to anthropogenic climate warming. *Nature* **393**, 245–249.
- Sarmiento, J. L., Gruber, N., Brzezinski, M. A., and Dunne, J. P. (2004). High-latitude controls of thermocline nutrients and low-latitude biological productivity. *Nature* **427**, 56–60.
- Schneider, B., Schlitzer, R., Fischer, G., and Nöthig, E. M. (2003). Depth-dependent elemental compositions of particulate organic matter (pom) in the ocean. *Global Biogeochem. Cycles* **17**(2), 1032, doi:10.1029/2002GB001871.
- Seitzinger, S. P., and Kroeze, C. (1998). Global distribution of nitrous oxide production and N inputs in freshwater and coastal marine ecosystems. *Global Biogeochem. Cycles* **12**, 93–113.
- Sharp, J. H. (1983). The distribution of inorganic nitrogen and dissolved and particulate organic nitrogen in the sea. In "Nitrogen in the marine environment" (Carpenter, E. J. and Capone, D. G. eds.). Academic Press, New York, Chapter 1. pp. 1–35.
- Siegenthaler, U., and Wenk, T. (1984). Rapid atmospheric CO₂ variations and ocean circulation. *Nature* **308**, 624–626.
- Sigman, D. M., and Haug, G. H. (2003). Biological pump in the past. In "Treatise On Geochemistry" (Holland, H. D., Turekian, K. K., and Elderfield, H., eds.). Elsevier, New York. pp. 491–528.
- Sigman, D. M., Robinson, R., Knapp, A. N., van Geen, A., McCorkle, D. C., Brandes, J. A., and Thunell, R. C. (2003). Distinguishing between water column and sedimentary denitrification in the Santa Barbara Basin using the stable isotopes of nitrate. *Geochem., Geophys., Geosys.* **4**(5), 1–20, doi:10.1029/2002GC000384.
- Sigman, D. M., Granger, J., DiFiore, P., Lehmann, M. M., Ho, R., Cane, G., and van Geen, A. (2005). Coupled nitrogen and oxygen isotope measurements of nitrate along the North Pacific margin. *Global Biogeochem. Cycles* **19**, GB4022, doi:10.1029/2005GB002458.

- Smith, W. O. J., Anderson, R. F., Moore, J. K., Codispoti, L., and Morrison, J. M. (2000). The U.S. Southern Ocean Joint Global Ocean Flux Study: An introduction to AESOPS. *Deep Sea Res. II* **47**, 3073–3093.
- Strous, M., Fuerst, J. A., Kramer, E. H. M., Logemann, S., Muyzer, G., van de Pas-Schoonen, K. T., Webb, R., Kuenen, J. G., and Jetten, M. M. S. (1999). Missing lithotroph identified as new planctomycete. *Nature* **400**, 446–449.
- Suntharalingam, P., and Sarmiento, J. L. (2000). Factors governing the oceanic nitrous oxide distribution: Simulations with an ocean general circulation model. *Global Biogeochem. Cycles* **14**(1), 429–454.
- Suntharalingam, P., Sarmiento, J. L., and Toggweiler, J. R. (2000). Global significance of nitrous-oxide production and transport from oceanic low-oxygen zones: A modeling study. *Global Biogeochem. Cycles* **14**(4), 1353–1370, doi: 10.1029/1999GB900100.
- Takahashi, T., Broecker, W. S., and Langer, S. (1985). Redfield ratio based on chemical data from isopycnal surfaces. *J. Geophys. Res.* **90**(C4), 6907–6924.
- Tsuda, A., Takeda, S., Saito, H., Nishioka, J., Nojiri, Y., Kudo, I., Kiyosawa, H., Shiimoto, A., Imai, K., Ono, T., Shimamoto, A., Tsumune, D., *et al.* (2003). A mesoscale iron enrichment in the western Subarctic Pacific induces a large centric diatom bloom. *Science* **300**, 958–961.
- Tyrell, T. (1999). The relative influences of nitrogen and phosphorus on oceanic primary production. *Nature* **400**, 525–531.
- Varela, M. M., Bode, A., Fernández, E., González, N., Kitidis, V., Varela, M., and Woodward, E. M. S. (2005). Nitrogen uptake and dissolved organic nitrogen release in planktonic communities characterised by phytoplankton size-structure in the Central Atlantic Ocean. *Deep Sea Res. I* **52**, 1637–1661.
- Villareal, T. A., Altabet, M. A., and Culver-Rymsha, K. (1993). Nitrogen transport by vertically migrating diatom mats in the North Pacific ocean. *Nature* **363**, 709–712.
- Vitousek, P. M., Aber, J. D., Howarth, R. W., Likens, G. E., Matson, P. A., Schindler, D., Schlesinger, W. H., and Tilman, D. G. (1997). Human alterations of the global nitrogen cycle: Sources and consequences. *Ecological Applications* **7**, 737–750.
- Ward, B. B., Kilpatrick, K. A., Renger, E., and Eppley, R. W. (1989). Biological nitrogen cycling in the nitracline. *Limnol. Oceanogr.* **34**, 493–513.
- Ward, B. B., Olson, R. J., and Perry, M. J. (1982). Microbial nitrification rates in the primary nitrite maximum off southern California. *Deep Sea Res.* **29**, 247–255.
- Wilkinson, F. P., Dugdale, R. D., and Barber, R. T. (1987). Effects of El Niño on new, regenerated, and total production in eastern boundary upwelling systems. *J. Geophys. Res.* **92**, 14347–14353.
- Williams, P. J. L., von Bodungen, B., Bathmann, U., Berger, W. H., Eppley, R. W., Feldman, G. C., Fischer, G., Legendre, L., Minster, J. F., Reynolds, C. S., Smetacek, V. W., and Toggweiler, J. R. (1989). Group report: Export productivity from the photic zone. In “Productivity of the Ocean: Present and Past” (Berger, W. H., Smetacek, V. S., and Wefer, G., eds.). Wiley, New York. pp. 99–115.
- Wu, J., Sunda, W., Boyle, E. A., and Karl, D. M. (2000). Phosphate depletion in the Western North Atlantic Ocean. *Science* **289**, 759–762.
- Yakushev, E. V., and Neretin, L. N. (1997). One-dimensional modeling of nitrogen and sulfur cycles in the aphotic zones of the Black and Arabian Seas. *Global Biogeochem. Cycles* **11**(3), 401–414, doi:10.1029/97GB00782.
- Zafriou, C. O., Ball, L. A., and Hanley, Q. (1992). Trace nitrite in oxic waters. *Deep Sea Res.* **39**, 1329–1347.
- Zehr, J. P., and Ward, B. B. (2002). Nitrogen cycling in the ocean: New perspectives on processes and paradigms. *Appl. Environ. Microbiol.* **68**(3), 1015–1024.
- Zehr, J. P., Waterbury, J. B., Turner, P. J., Montoya, J. P., Omoregie, E., Steward, G. F., Hansen, A., and Karl, D. M. (2001). Unicellular cyanobacteria fix N₂ in the subtropical North Pacific Ocean. *Nature* **412**, 635–638.